



ESN200

Operation and Installation Manual

Dual channel Multi frequency Echo sounder

Display unit ESN200-SB

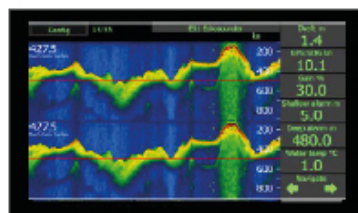

24 V DC

LAN communication with Display
(Multiple displays available)

Electronic / Transceiver unit
JB70E2-SA



24 V DC - 115/230VAC

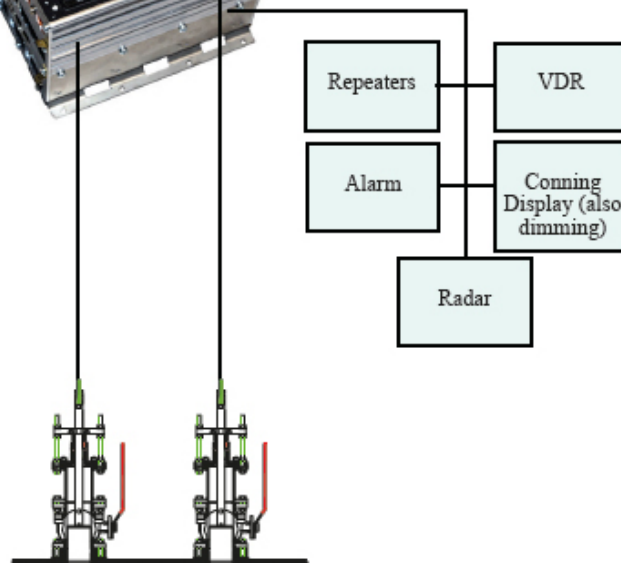

Document no: **DM-G005-SB**

Rev: 2111

For software rev: 1.1.2

Date: 2021.09.29

IMPORTANT

When doing service or repair, please wait two minutes after power off, before unplugging internal connectors.

Do not run the sounder for a long time with the transducer in air.
The transducer may be damaged.

Weitergabe sowie vervielfältigung dieser unterlage, verwertung und mitteilung ihres inhaltes nicht gestattet, soweit nicht ausdrücklich zugestanden. Zuwiderhandlungen verpflichten zu schadenersatz.

Toute communication ou reproduction de ce document, toute exploitation ou communication de ou son contenu sont interdites, sauf autorisation expresse. Tout manquement à cette règle est illicite et expose son auteur au versement de dommages et intérêts.

Copying of this document, and giving it to others and the use or communication of contents thereof, are forbidden without express authority. Offenders are liable to the payment of damages.

Sin nuestra expresa autorización, queda terminantemente prohibida la reproducción total o parcial de este documento, así como su uso Indebido y/o su exhibición o comunicación a terceros. De los infractores Se exigirá el correspondiente resarcimiento de daños y perjuicios.

Contents

INTRODUCTION	4
Specification	6
MECHANICAL INSTALLATION	7
Installation Details	8
CONFIG SOFTWARE SETUP	11
ES Setup	12
Transducer setup	12
Main setup	15
Options	16
Options: Synchronised pinging	17
Communications Setup (NMEA)	18
Accepted NMEA inputs	21
AUX Setup	22
Runtime Screen Setup	25
Display setup	29
Screen setup	29
Remote dimming setup	30
Alert setup	31
Connection between JB70E2 and Display units	40
Service software	40
Display Unit setup – Network settings	40
JB70 setup	41
Network setup	41
Printing	43
Printers	43
Setup print button in Runtime Screen	43
Setup printer type in "Print Setup" menu	43
Connecting the printer	44
Network printing	44
PC connection Setup	45
Upgrading software	46
USER INFORMATION	47
Introduction	47
Auto Functions	49
Manual mode	49
Screen Configuration	50
24 Hours History	53
Extended logging of history	54
DIAGNOSTICS	56
APPENDIX 1: INSTALLATION DRAWINGS	60
ENS518-SA Transducer selector	63
APPENDIX 2: REMOTE CONTROL	65
Table of abbreviations	66

Introduction

The SKIPPER ESN200 is a dual channel echosounder.

Each channel is frequency programmable. It is made to fulfil all ISO/IMO standards, as well as the modern IEC standards for maritime equipment and alarm handling.

Features

The ESN200 is a navigational echo sounder system that is made to fulfil the needs of a modern SOLAS vessel. Its aim is to be automated, so that the user does not need to adjust settings. But it also allows the user to adjust if they feel the need.

The ESN is part of the SKIPPER Multi family, allowing the use of LAN to interconnect systems and use multiple screens.

Features include:

- Easy and logical operation via a touch display, with fully automatic settings
- Possibility of multiple control units
- Fully integrable and frequently updated with the latest integration standards
- Remotely accessible
- Internal diagnostics and Built in test
- 2 simultaneous channels, each of which is frequency controllable
- 7 available frequencies. 24, 30, 33, 38, 50, 100, 200kHz
- 3 IMO approved frequencies. 38, 50, 200kHz
- Other available transducers from SKIPPER: ETN024 24kHz

The ESN200 comprises of one Display unit, one Electronic unit and up to 2 transducers

ESN200-SB Display unit: Contains a 2 NMEA outputs and 2 NMEA inputs used solely for dimming, or normal DPT outputs. An RJ45 connector is used for LAN communication (IEC61162-450) to the Electronic/transceiver unit. Power input 24VDC

JB70E2-SA Electronic and transceiver unit; This unit is the echosounder producing the acoustic signals and processing the returns to give the appropriate outputs for depth. It contains connections for 2 transducers, 2 LAN ports for connection to the bridge or control units, auxiliary inputs and outputs, 5 NMEA outputs and 3 inputs, and power input 24VDC and 110-230VAC. This unit is mounted on or close to the bridge, with long cables coming from the transducers.

If 7 outputs is not enough, the NMEA will typically be sent to a splitter/Expander such as the SKIPPER NE108-SA to give the information to the bridge/alarm system and VDR.

Overview

Display unit ESN200-SB

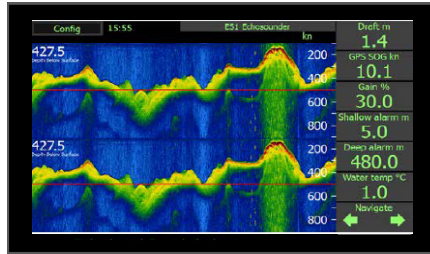

24 V DC

LAN communication with Display
(Multiple displays available)

Electronic / Transceiver unit
JB70E2-SA

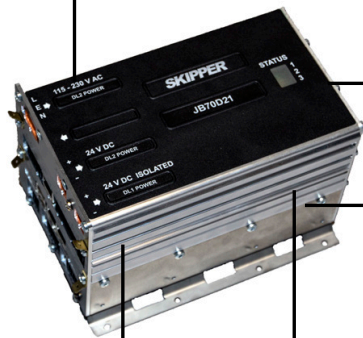

24 V DC - 115/230VAC

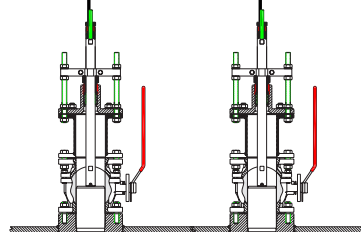
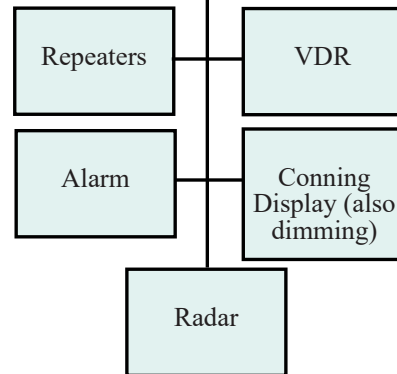

Options for tank,
sea valve (single and double hull)
and retrofit.

Specification



ESN200 Navigation Echo Sounder

Specifications

Channels	Dual channel echo sounder
Transducer connectors:	2 Transducer connectors in Electronic / transceiver unit.
Frequencies	7 set delectable frequencies 24kHz, 30kHz, 33kHz, 38kHz, 50kHz, 100kHz and 200 kHz
Power Supply	DC: 20 - 32 V and/or 115/230VAC
Power Consumption	Display unit. Nominal 6W Electronic unit 20W
Display ESN200-SB	9" Resistive touch. 400NITS Dimensions: 242 x 158mm Weight: 1.1kg 1 x LAN 2 x NMEA 0183 Outputs (IEC61162-1) 3 x NMEA 0183 Inputs (IEC61162-1)
Electronic unit JB70E2-SA	Dimension: 115x115x180mm Weight: 1.5kg 2 x LAN (IEC61162-450) 5 x NMEA 0183 Outputs (IEC61162-1) 3 x NMEA 0183 Inputs (IEC61162-1) 1 x AUX in 2 x AUX out 1 x Relay out
Ranges	Selectable from 0 - 5 m to 0 - 5000 m
Approved SKIPPER transducers with expected depth limits	50/200kHz ETS50200T/G: 1m-750m 200kHz ETN200T: 1m - 350m 200kHz ETN200ST/G: 1m - 250m 50kHz ETN050T/G: 1.5m - 750m 38kHz ETN038T/G: 2m - 1200m
Non-approved SKIPPER transducers expected limit	24kHz ETN024T/G: 2m - 2100m
Measuring Accuracy	1-10m: Accuracy 0.1m Resolution=0.1m 10m-100m Accuracy 1% Resolution 0.1m 100m-5000m: Accuracy 1%. Resolution Display=1m NMEA=0.1m
Output power	Nominal 700W. Max >1000W
User functions	Auto mode (for all settings) Manual control: Gain, Power, TVG, Frequency Transducer setup by part number Diagnostic screens / BIT Dimming (remote or local)
Print/Archive function	Printers: By use of EPSON 350, OKI 280Eco, OKI Microline ML1190eco. Text printer EPSON TM-T20III (USB) Network printers / Review: Service software via LAN Extended Internal Logging, by USB or SD
Depth alarms	BAM compatible (IEC62923) ALF or ALR. Internal sounder. Relay output and AUX in/out
Options	IR31Dim Remote/Automatic dimming unit CD401MR-SB Multi-repeater ESN200-SB Extra Displays Code AC-G001 Synch functions Code AC-G002 GPS printer function
Classification	MED B approved

Overview

Display unit ESN200-SB

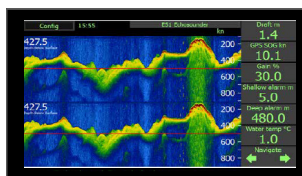

24 V DC

LAN communication with Display
(Multiple displays available)

Electronic / Transceiver unit JB70E2-SA

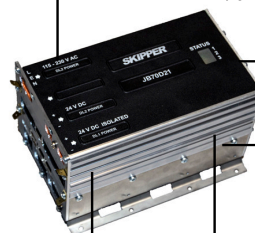

24 V DC - 115/230VAC

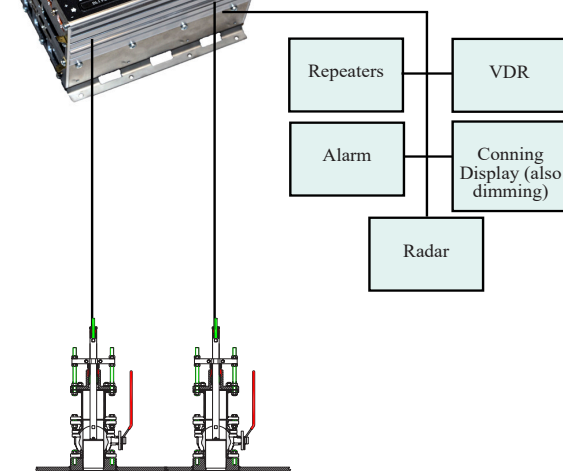

Options for tank,
sea valve (single and double hull)
and retrofit.



SKIPPER Electronics AS
Norway
E-mail: sales@skipper.no
www.skipper.no

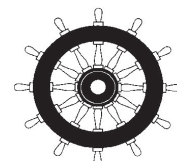

Mechanical installation

Positioning of the transducers

- A transducer should be installed in an area securing optimal measurement free from noise and aeration.
- Transducers are normally installed in the noise free area in the foreship (see A on fig.)

Optimal system operation is achieved by fitting the transducer as deep as possible on the hull. The transmitting surface of the transducer must be installed horizontally.

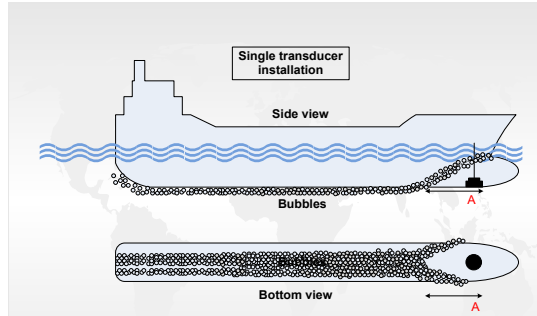

Do not mount transducers close to the propeller or aft of other hull installations (outlets, vents or other protruding details). It is necessary to select a part of the hull that is submerged under all load and speed conditions, and to avoid positions where air is trapped in heavy weather.

If a flat, horizontal section is not available for transducer fitting, the shipyard must construct a suitable bed.

Larger vessels are often fitted with two transducers, one fore and one aft (see fig.)

The fore transducer is the primary transducer, (normally 50 kHz).

The aft transducer is a secondary transducer, (normally 200 kHz).

An aft transducer may be troubled with aeration and turbulence and may not operate in higher-speed. It is normally solely used to measure aft depth in shallow water / slow speed.

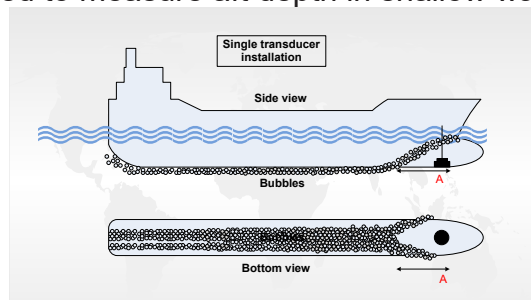

Installation Details

Refer to SKIPPER’s installation procedures in the appendix and on our web site www.skipper.no regarding information about sea valve, tank installation, welding, cable glands etc

Note:

Protect the active element of the transducer and **do not paint the surface.**

Transmission in **the air must be avoided!** This may cause mechanical damage of the element.

Transducers should be positioned as close to the bow as possible within the first 3rd of the ship. It should be possible to draw a cone of +/-60 degrees underneath the transducer without any objects entering the cone. The face of the transducer should be horizontal with no more than 5 degrees tilt. If this is not possible a blister should be assembled. This should have at least 0.3m of flat area in front of the transducer, and be tear drop shaped.

Generally there should be nothing in front of the transducer that can cause turbulence and to the side nothing within 0.5m.

Positioning/wiring of the units

Length	Transducer cable type: 1 x shielded pair (twisted pair recommended if available)
25/40m	Connected transducer cable
40-100m	1.5mm
100 – 300m	2.5mm



Connectors supplied with the system



ZZN-01126 Relief Housing,
3 pole snap-on.
WAGO: 232-633

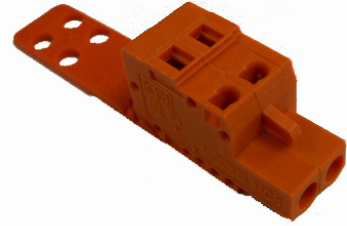

ZZN-01124 Plug, Female 2
pole, 231-302_032-000



ZZN-01136 Plug, Female
3 pole with locking levers,
231-303/037-000



ZZN-01130 Connector, Fe-
male w/ejectors 3x2 pole, black
WAGO 713-1103/037-000

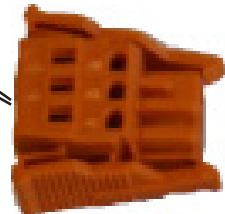

ZZN-01136 Plug, Female
Coded and labeled for transducers.
3 pole with locking levers,
231-303/037-000



ZZN-01120 Connector Fe-
male w ejectors 6x2 pole, black
WAGO 713-1106/037-000



ZZN-01123 Strain relief
plate, 6x2 pole, width 11 mm
WAGO 713-126



ZZN-01123 Strain relief
plate, 6x2 pole, width 11 mm
WAGO 713-126

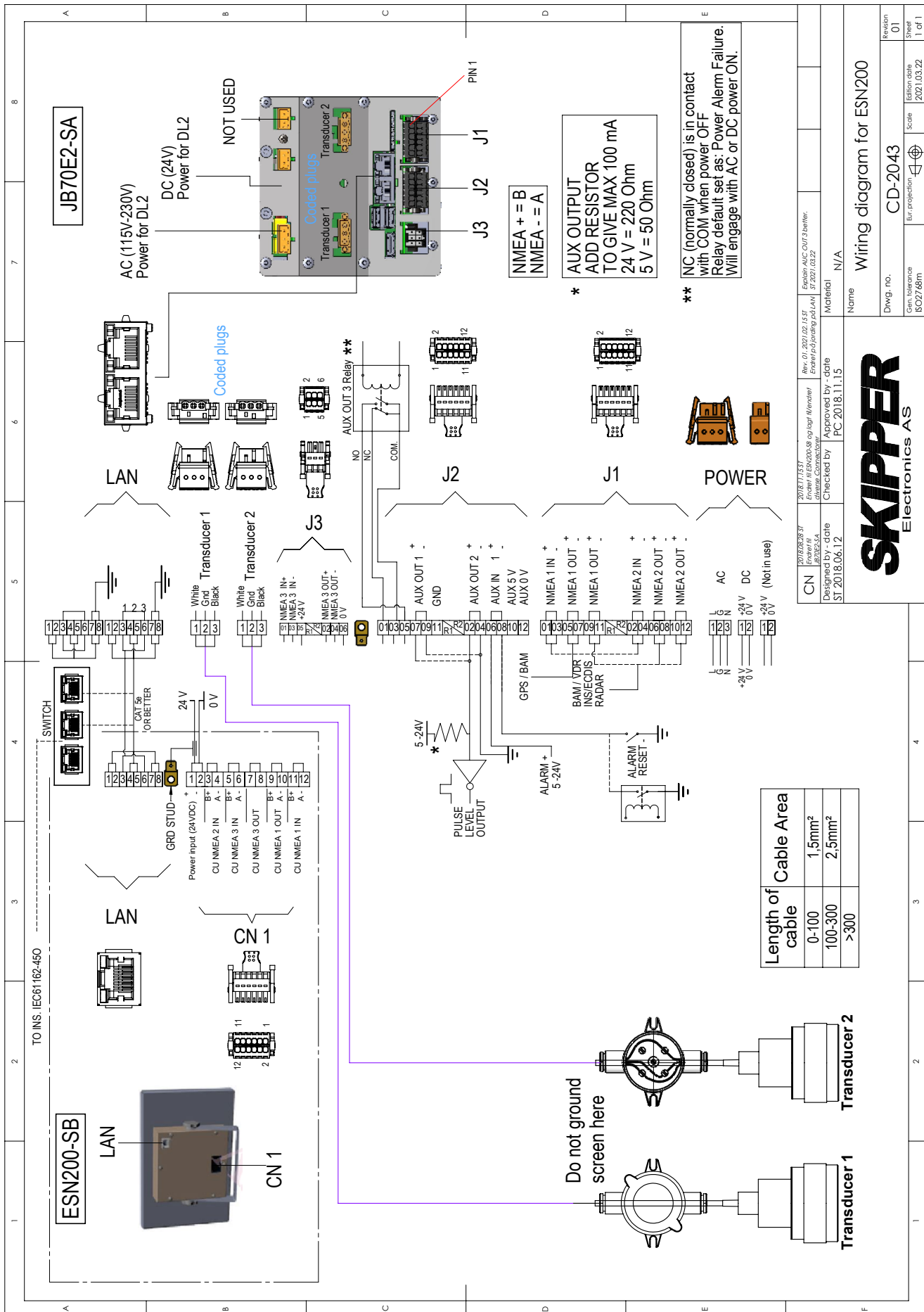

Rev. 01 2021.02.15 ST Entered in ESN200-30-02-15 ST Entered in ESN200-30-02-15 ST	Rev. 01 2021.02.15 ST Entered in ESN200-30-02-15 ST Entered in ESN200-30-02-15 ST	Material	N/A
Designed by - date	Approved by - date	Name	Wiring diagram for ESN200
Checked by	PC 2018.11.15	Dwg. no.	CD-2043
		Scale	1:1
		Sheet	1 of 1
		Scale	1:1
		Scale	1:1



CONFIG software setup

The ES system setup is accessed by pressing “CONFIG” button in left upper corner.

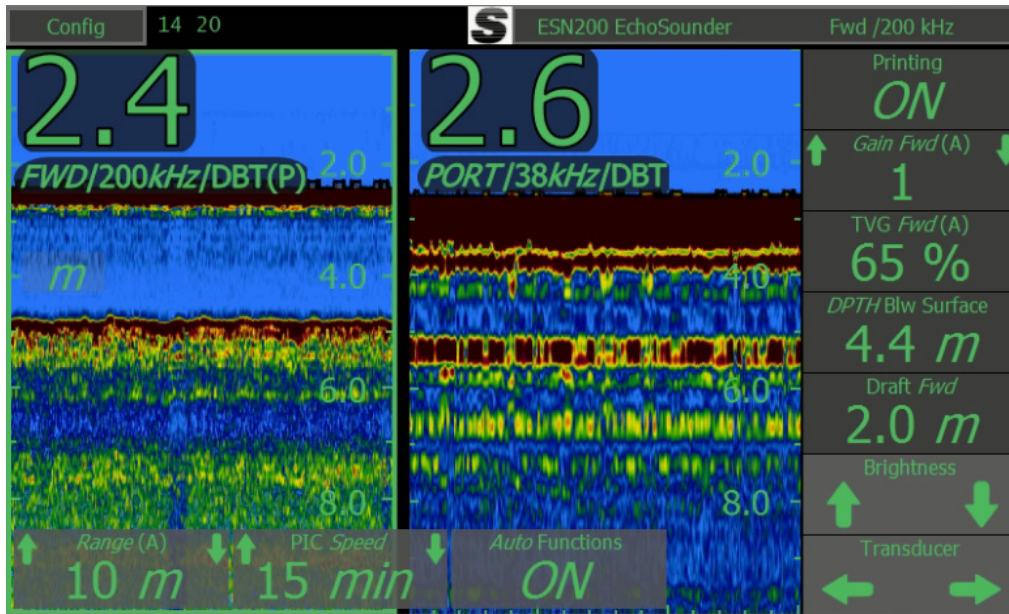

Available Setup screens:

- Runtime screen setup
- Alert setup
- Diagnostics
- ES Setup
- Communication setup (NMEA)
- 24 hours history
- AUX Setup
- JB70 Setup
- Logging Setup
- Display setup
- Print Setup

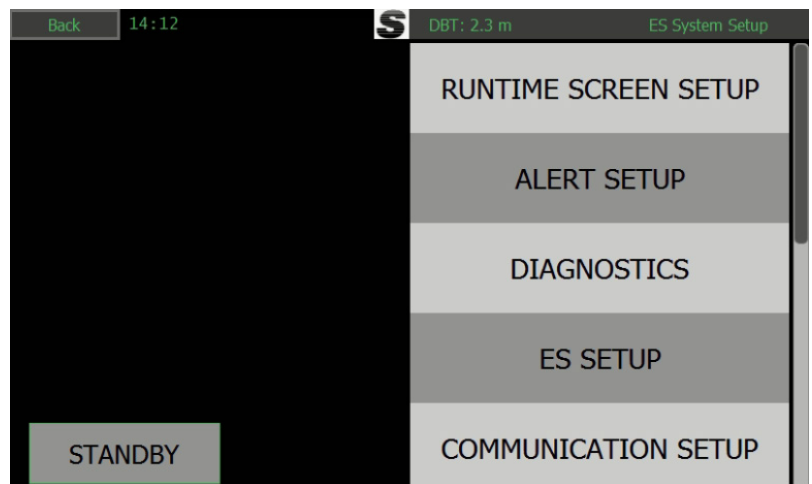

Additionally the “STANDBY” button is available to put system in standby for a period not in use. Will switch off the display and pinging.

Transducer settings and output settings are password protected for changes.

The password for all units is ‘service’. The password will be remembered for 1 hour, or until reboot of the system.

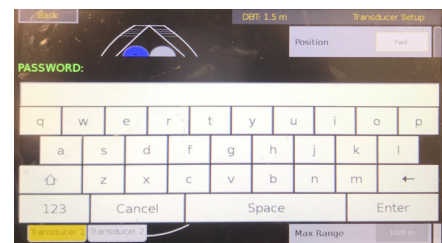

ES Setup

Transducer setup

Once connected the system requires the installer to identify which transducer is connected to which of the 2 connectors. System required 1 approved transducer to be installed (currently 200/50/38 kHz), the second can be any transducers.

The approved transducer should be set to primary, and this is the transducer that reports the standard DPT output messages.

Both connectors can have a transducer fitted. To select the correct fixture, start the system and go to the config menus, and then the ES setup.

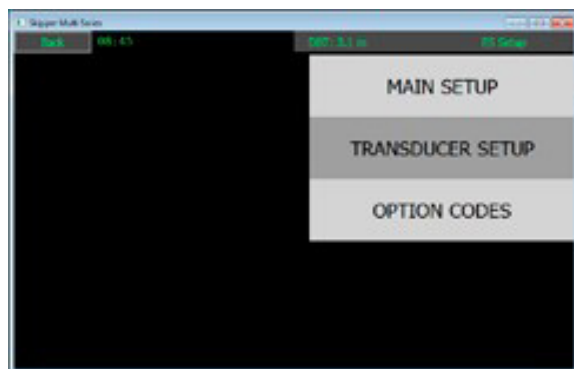
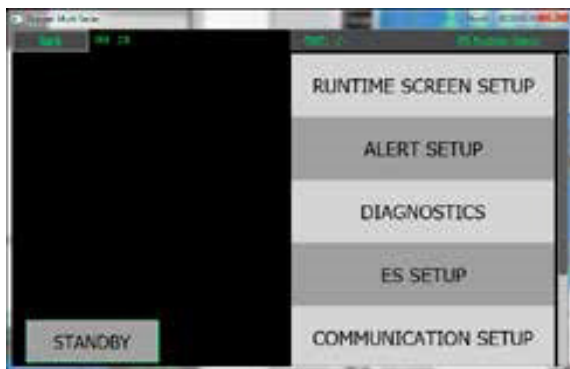

Here you can select the transducer menu and by clicking on the transducer connector port you can move the transducer to the appropriate area of the vessel, and select the transducer, by part number. This will change the parameters to match your transducer.

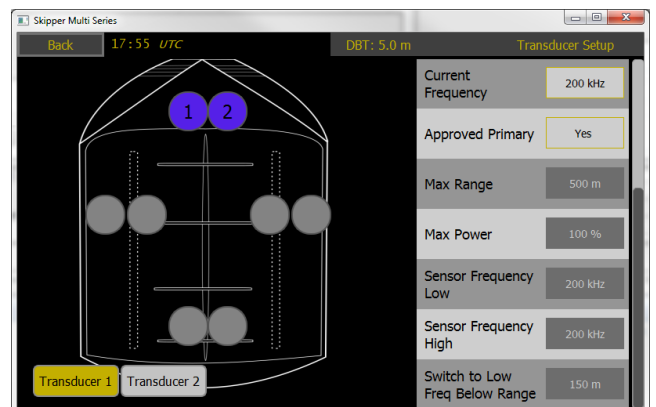
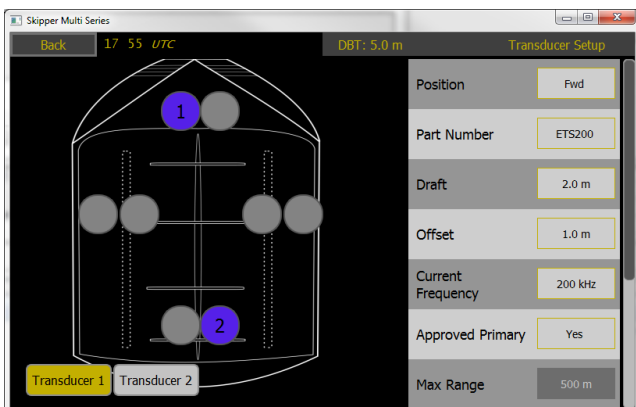

If you are not using a standard transducer, then select other, and the frequency, max power and max expected range can be set for that

Selectable transducer types

Part number	Type	Approved for use
ETN050	50 kHz of types ETN50(X)G, ETN50(X)T	Yes
ETN200	200kHz of types ETN200(X)T	Yes
ETN200S	200kHz of type ETN200S(X)G, ETN200S(X)G	Yes
ETN50200	Combined 50 and 200kHz of types ETN50200(X)G and N50200(X)T	Yes
ETN038	38 khz	Yes
8B-200	Furuno 200kHz Transducer	Yes**
S-50-18	SIMRAD 50kHz (500W max)	No
Other	Any other	No
ETN024	24kHz	No

** The named transducers have BV reviewed tests, proving they work to specification with the system.

Standard transducers have the required values set.

'Other' transducers can change values in the settings. See section 'Other Transducers'

At least 1 installed transducer should be within the SKIPPER approved list.

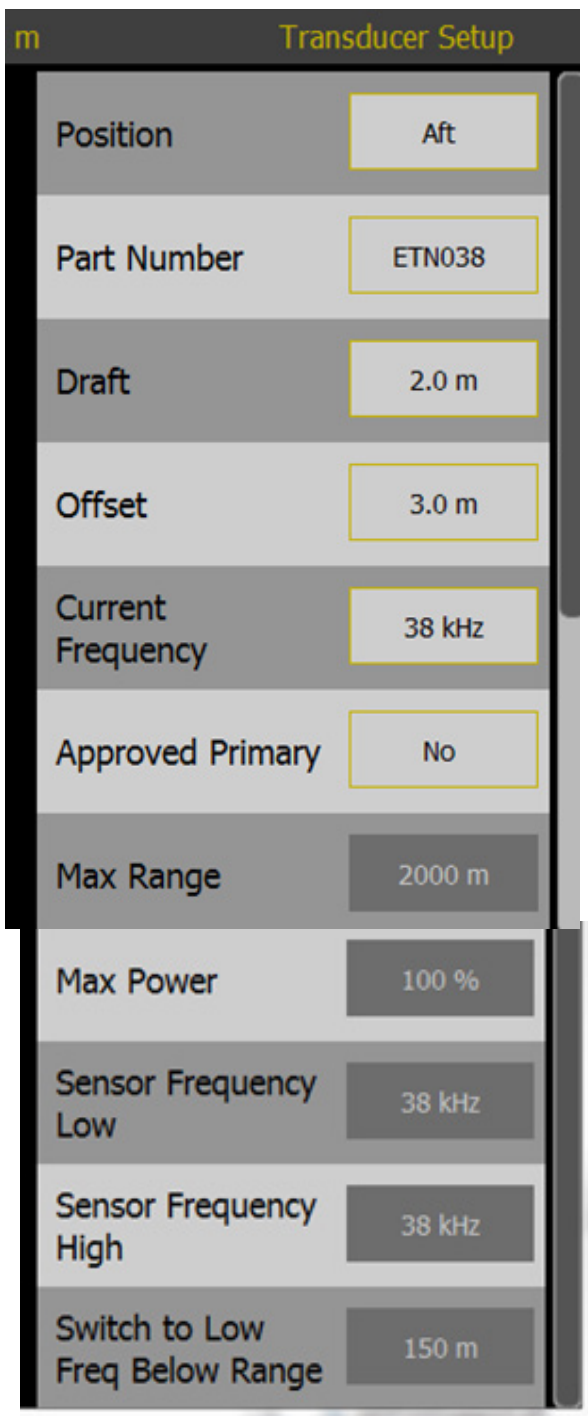

Position (FWD,AFT,PORT,STRB)
Part number, or other Approved part numbers, are ETN050 (50kHz) ETN200/ETS200 (200kHz) ETN200S/ETS200 (200kHz for valve) ETS50200 (combined 50/200kHz) ETN38 (38 kHz)
Draft of this sensor, can be changed on main screens
Offset. Distance from transducer to keel
Current Frequency 200 or 50kHz. – The current frequency in use on this transducer. (selectable on dual frequency transducers)
Approved Primary: Any of the above transducers can be primary, if a non approved transducer is used as the second transducer, this must not be primary

Settings available only in the case Part number is 'other':

Max range (set automatically for part number, adjustable for 'other')
Max Power: This system is up to 1kW Peak power, and this can be limited if required
Sensor frequency low: if the sensor is a dual frequency then this is s the low frequency or main frequency if not (available frequencies are 24, 30, 33, 38, 50, 100, 200 kHz)
Sensor frequency high: If dual frequency this is the high frequency
Switch to low Freq below Range: At this depth a dual frequency transducer will switch between low/high

Main setup

Echosounder parameters are set by default, but can be adjusted in the “ES Setup”, “Main Setup”

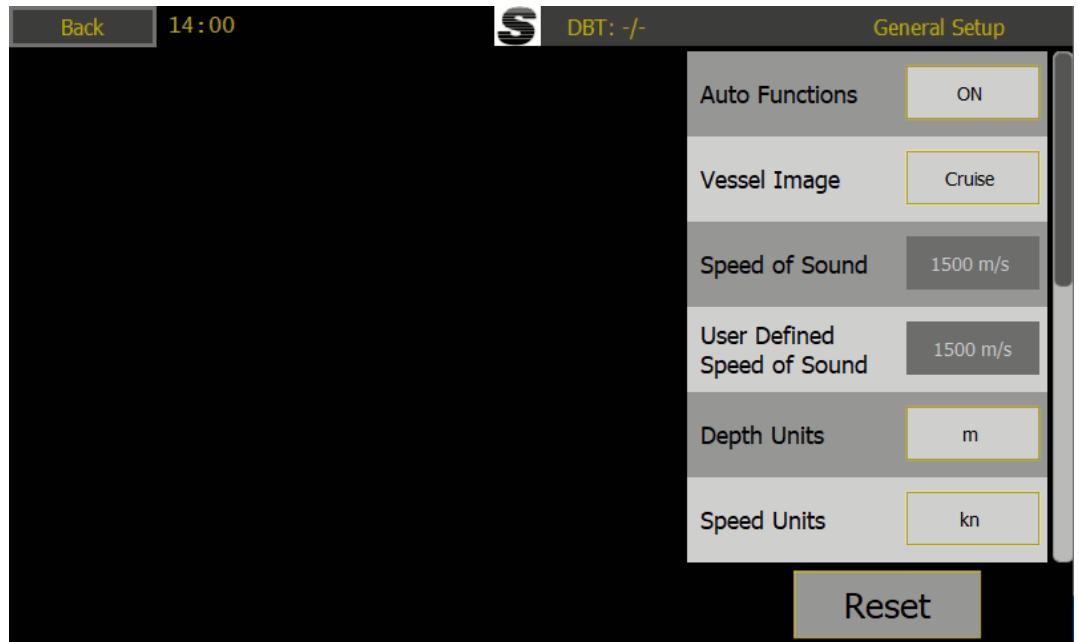

Auto functions will take control of range, gain (and frequency for ETS50200)
Vessel image: Change the design of the vessel in the menus
Speed of sound can be changed with an option or with a temperature input. User can only define the sound speed with an option code.
Depth units (also available on screen). m (meters) ft(feets) fm (fathoms)
Speed units: kn, m/s, Mi/h
Power Ch1: Power output 0-100% Normally controlled by Auto when Auto function ON
Gain Channel 1: Receiver Gain 1-12. Normally controlled by Auto when Auto function ON
Power Ch2: Power output 0-100% Normally controlled by Auto when Auto function ON
Gain Ch2: Receiver Gain 1-12. Normally controlled by Auto when Auto function ON
Pinging multiplexed: YES/NO. No: The two transducers will ping simultaneously. YES: Each transducer will ping every second time. This to avoid interference if having two transducers with the same frequency
Save setup: Save setup to internal memory
Restore setup: Restore a saved setup
Reset will reset the settings to default

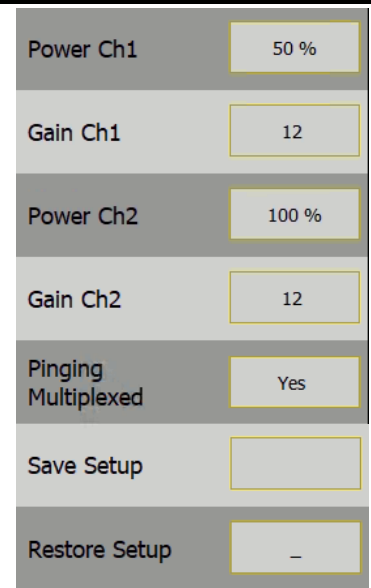

Options

Some settings are not changed as standard, but can be accessed by entering a code (available from SKIPPER)

<p>Option Code <input type="text"/></p>	<p>Codes can be entered to allow the options to be activated</p>
<p>Speed of Sound <input type="button" value="Disabled"/></p>	<p>Speed of sound, is activated by unique code from SKIPPER</p>
<p>Mute <input type="button" value="Disabled"/></p>	<p>Mute, a function to stop all pinging. A 'M' Symbol will show on screen. Mute is approved for ISO9875</p>
<p>Mute Without Alert <input type="button" value="Disabled"/></p>	<p>Mute, a function to stop all pinging, after a period an alarm will activate. A 'M' Symbol will show on screen. This mode is not approved for ISO9875.</p>
<p>Advanced Diagnostic Setup <input type="button" value="Disabled"/></p>	<p>Advanced diagnostic features can be shown by activating this option</p>
<p>Bottom Detection Setup <input type="button" value="Disabled"/></p>	<p>Automatic features can be changed when this setup is activated</p>
<p>Alarm Sounder Off <input type="button" value="Disabled"/></p>	<p>The alarm sounder can be disabled if this option is activated</p>
<p>Advanced System Settings <input type="button" value="Disabled"/></p>	<p>Advanced system settings can be changed if this option is activated</p>

Asynchronised pinging with external acoustic system Not Master status

The mute option can be used for stop the pinging.

This mode may set a too low number of pings for IMO requirement.

The options "Mute" and "Mute without alarms" will require an option code to enable.

To synchronise with other systems use the 'ping now' function. The system will only ping if it is finished with its expected receiver time. Pinging too fast will probably cause interference within this system, that may be detected as a false bottom detection

Options: Synchronised pinging

The ESN200 will by default ping on both transducers simultaneously. The time between each ping is depending on the range setting. Shallow water range will ping more often than deeper water range.

For the system to be MED (Wheelmark) approved it must ping at least :

2-20m range = Minimum 36 ping per minute.

20-200m range= minimum 12 ping per minute,

This gives some leeway in when the system pings.

Multiplexed ping

“Config”, “ES Setup”, “Main Setup”

Multiplexed “ON” the system will take turns to ping on channel 1 and channel 2. This can be used if 2 transducers of the same frequency are installed and effect each other.

Synchronisation with external acoustic systems

The ESN200 may have to work with other acoustic systems without interference.

The AUX output “ping out” is an indication for the external equipment to ping synchronised with ESN200. In this mode the ESN200 is the master.

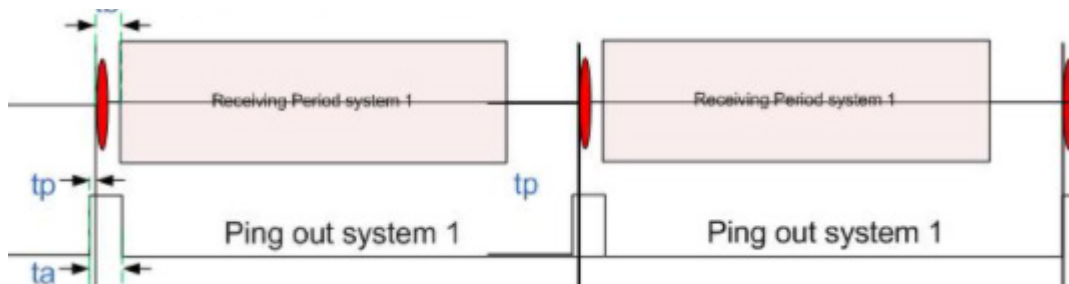

Asynchronised pinging with external acoustic system

AUX output When “Sync Out +/-” enabled on one of the AUX outputs it will half the amount of pings to allow another system to ping. (For asynchronized pinging of two systems)

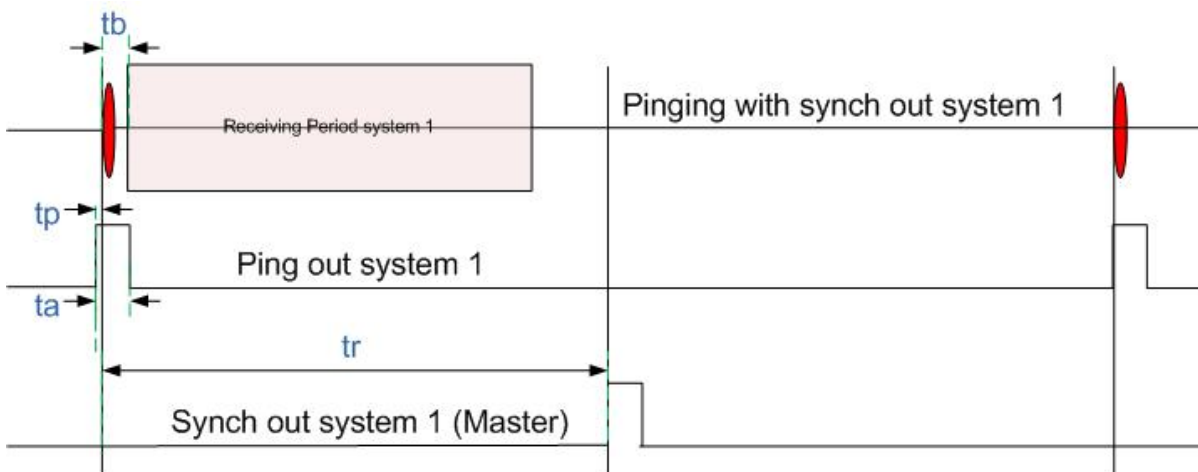

Communications Setup (NMEA)

Outputs

The communications menu allows the NMEA messages to be selected for the output.

On this system there are 7 NMEA outputs. 5 in the Electronic unit JB70E2-SA

NMEA1 OUT x 2

NMEA2 OUT x 2

NMEA3 OUT x 1

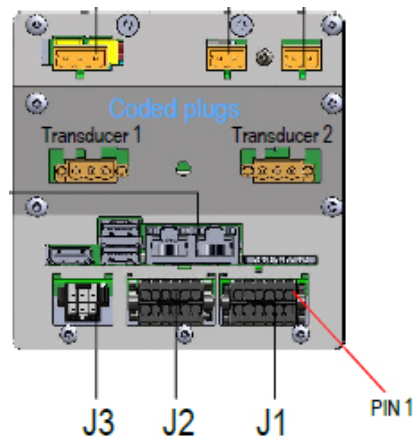
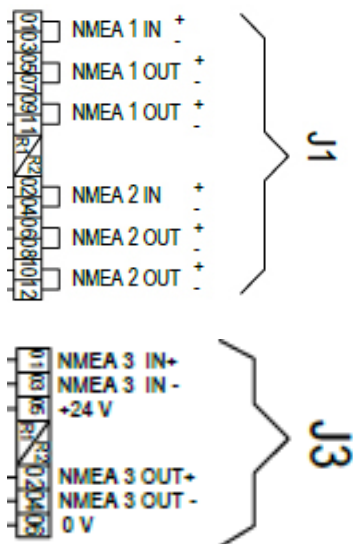

2 NMEA outputs on the display ,

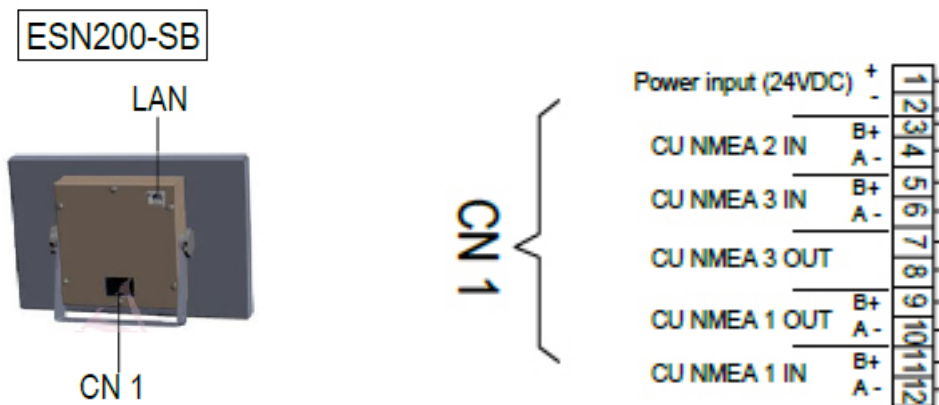

NMEA style sentences will be shown as the 3 letter mnemonic when the sentence is sent or received. There are 2 channels

1. Output for NMEA
2. LAN input and output for IEC61162-450 messages

This port can provide communication both by TCP/IP V4.0 and using IEC61162-450. If being used it requires a network that does not exceed 60kbits/second directed to the system. The system will exert/receive a maximum load of 40 datagrams/second. The network load should not exceed 20Mb/s, The LAN ports on this system support IEC61162-450 V1, and V2 and IGMP V1 to 3.

The Baud rate output 4800, 38400 or 115200. System reports at 1Hz.

The left side show a terminal emulator that shows the input or output messages of the selected channel. Pressing 'Message headers' will show the full message. Exact formats for these sentences can be found in the relevant IEC standards.

The screenshot displays the 'ES Communications Setup' interface. At the top, it shows 'Back', '14 56', 'DBT: 3.1 m', and 'ES Communications Setup'. The main area is split into two panels. The left panel, titled 'NMEA 1 output message headers:', lists several NMEA sentences: \$SDDBK, \$SDDBS, \$SDDBT, \$PSKPDPT, and \$DDPT. Below the list are two buttons: 'Output' and 'Full messages'. The right panel shows configuration options for 'Channel' (NMEA 1), 'DPT' (ON), 'PSKPDPT' (ON), 'DBS' (ON), 'DBK' (ON), 'DBT' (ON), and 'Alarm' (off). A legend at the bottom left identifies message colors: green for 'Valid message', yellow for 'Message with invalid data', blue for 'Unrecognized message', and red for 'Message with error'.

DPT (default ON)	\$SDDPT Depth below Transducer, offset to keel, Max range
PSKPDPT (default ON)	\$PSKPDPT Depth below Transducer, offset to keel, Max range, position frequency ,text ,
DBS (default OFF),	\$SDDBS Depth below surface in feet, meters, fathoms
DBK (default OFF),	\$SDDBK Depth below keel in feet, meters, fathoms
DBT (default OFF),	\$SDDBT Depth below transducer in feet, meters, fathoms
Alarm (default ON)	\$SDALR, \$SDALF, \$SDALC The selected alarm type (ALF or ALR) will be sent via this port. See section "Alert setup and usage"

Default is ALARM outputs set to the ALF version of the standard

PSKP sentences are proprietary for SKIPPER and has the following format.

\$PSKPDPT,x.x,x.x,x.x,xx,xx,c-c*hh<CR><LF>	
_____	Check sum, possible to turn on/off (see screen 8)
_____	Transducer location AFT, FWD, PORT, STB
_____	Echo sounder channel number (1/2)
_____	Signal strength
_____	Maximum range scale in use, meters
_____	Offset to keel, meters
_____	Water depth relative to transducer, meters

Example \$PSKPDPT,3.7,0.0,500.0,,3,FWD*11

\$SDALF,a,b,c,hhmmss.ss,d,e,f,ggg,x.x,y.y.z.z,h,j--j*hh<CR><LF>
<p>a = Total number of sentences for this message b= Sentence numer c=sequential identifier hhmmss.ss = time of last change (if clock available) d=Alert catagory (A,B,C) e= Alert priority (E,A,W,C) f= Alert state (A,S,N,O,U,V) g= Manufacturers mnemonic code (Not used) x= Alert identifier y=Alert instance (1-999999) z= Revision counter (1 to 99) h=Escalation counter (0 to 9) i=Alert text</p>
Example: see page 34

Accepted NMEA inputs

Format	Function
\$__DDC,X,yy,X,C*nn	Dimming function X= O,N,K,D , YY is % the system will accept X and adjust to the user set level (See dimming)
\$__XDR,D,x.x,M,pos,D,x.x,M,pos,D,x.x,M,pos,*nn	If the vessel has a draft sensor, the following input can be used to automatically adjust the draft Draft sensor depth values. x.x - draft value pos - transducer position (fwd, aft, prt, str)
\$GPZDA,	Time and local time, The system will show UTC or Local time if available in the message
\$GPVTG, Speed	GPS Speed Logged in history
\$GPGGA	GPS Position Logged in history
\$GPRMC	Position and speed logged in history
ACN,102104.00,,230,<1-999999>,s,c*hh	Silence alarm for 30 seconds ALF
ACN,102104.00,,230,<1-999999>,q,c*hh	Request/Repeat ALF info ALF
ACK,xxx*hh<CR><LF>	Acknowledge alarm ALR(B).
ACK,xxx*hh<CR><LF>	Silence alarm ALR(A)
Internal UDP	The System can also take information from other SKIPPER devices within the same network for display on screen or for logging
\$PSKPSYC,0*nn	Mute off
\$PSKPSYC,1*nn	Mute on

The Communications on NMEA are 4800, 8 data bits, 1 stop bit. Baud rate can be changed to 32400 or 115200

AUX Setup

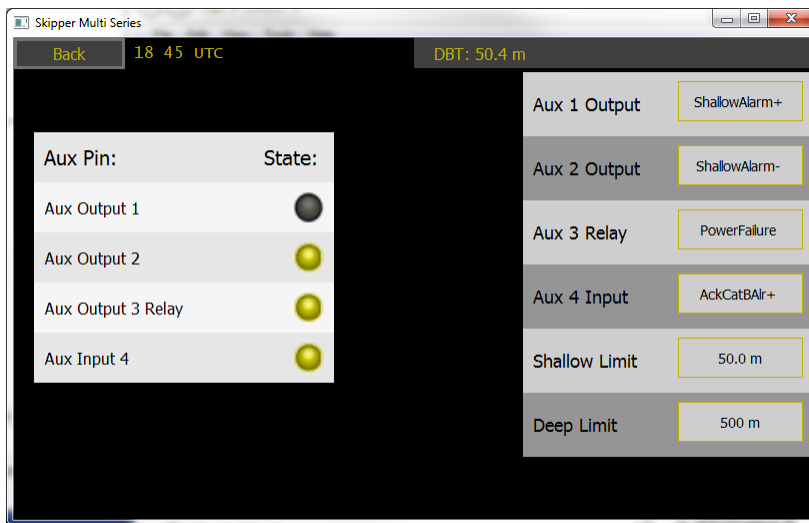

The ESN200 system has

AUX1 Output: optoisolated auxiliary output.

AUX2 Output: optoisolated auxiliary output.

AUX3 Relay: Relay Output

AUX4 Input: optoisolated auxiliary input.

The state of these can be seen on this screen on the left and the functions are selected on the right.(+/- meaning the function can be active hi or active low)

Aux 1 and 2 output: An opto-isolated output with the following available functions:

- ShallowAlarm+/- Changes on shallow alarm
- ShallowAlrBeep+/- 3changes every 10 seconds as defined in standard. To be connected to external beeper
- DeepAlarm Changes when deeper than limit
- DeepAlrBeep+/- 2changes every 10 seconds as defined in standard. To be connected to external beeper
- ShallDeepAlr+/-both alarms
- DeepAlrBeep+/- beeps for both alarms
- ShallDeep limit+/- Out put change state when outside set limit.
- Power failure, changes when no power on JB70
- Disabled

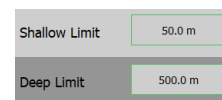

- Sync Out +/- Changes when a second system can ping. When enabled on one of the AUX outputs it will half the amount of pings to allow another system to ping.(For asynchronized pinging of two systems)
- Ping +/- Changes when the system is sending a ping, this can be used as a trigger to other systems wishing to ping at the same time
- Mute Confirm +/- changes state once the system has acknowledged that a mute is active
- Ready to ping +/- Changes to active when the system pings, and deactivates, when the system has finished receiving the echo. This can be used to trigger other systems.

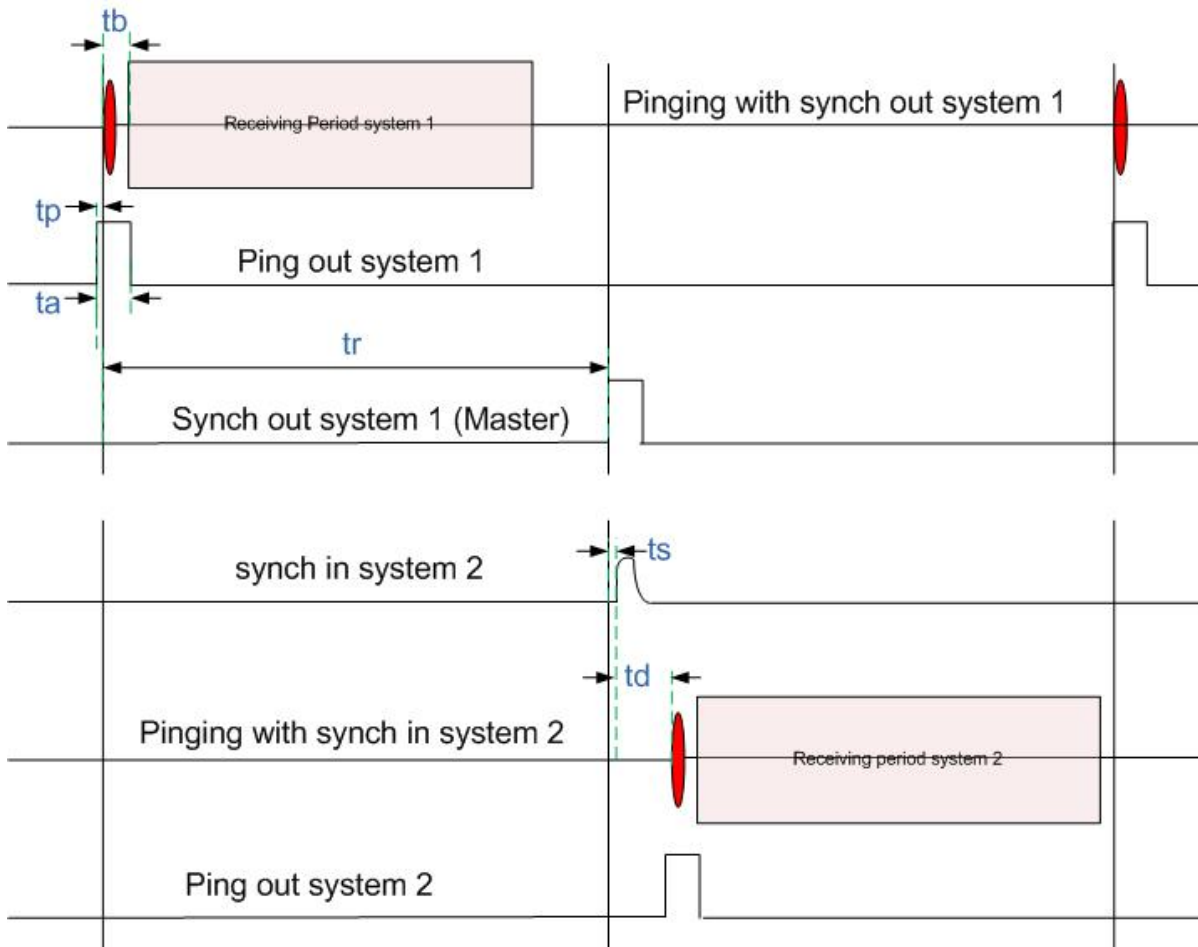

Aux 3 Relay output: As above except ping

Aux 4 input:

- AckCatBAI +/- Acknowledge and alarm (Not shallow water)
- AckAllAI +/- Acknowledge and alarm (Option)
- SilenceAI +/- Silence an alarm
- Synch In +/- Synch with other system
- Mute +/- Mute in - Stops this system pinging - shows M on screen in warning triangle, when muted
- Disabled

Synchronising systems

when activated, there are a number of methods to synchronise systems:

A) 1 system is master - The master system uses 'sync out' and this is used to trigger a second system. The master system gives other system (normally a second ESN200) this signal and assumes it will use the same amount of time until ready. This is 1 way communication only and may not be reliable if the second system does not use the same range.

B) No master.- The systems use 'ready to ping' output connected to 'Sync in' input of the next system, making a chain of systems, that take turns to ping.

(see note below)

C) Slave using the 'sync in' function the system pings on request. A feedback can be given either with ping output indicating when the system is pinging, or ready to ping, indicating the system is both pinging and detecting (See note below)

synch in, Mute, inputs are also available via NMEA using the EPV command (see appendix)

Please note:

Mute/synch function only available as special option with option code from SKIPPER. and may make the echosounder non Wheelmark approved.

Synch in/Mute will create a warning if the number of pings are outside IMO requirement 36 pings per minute in 20m range (or less) and 12 in >20m range.

The opto-isolated input and outputs need a voltage between 5V and 30V to operate. If isolation is not important, this 5v can be taken from the connector, otherwise it should be supplied from an external source. Connection is as follows

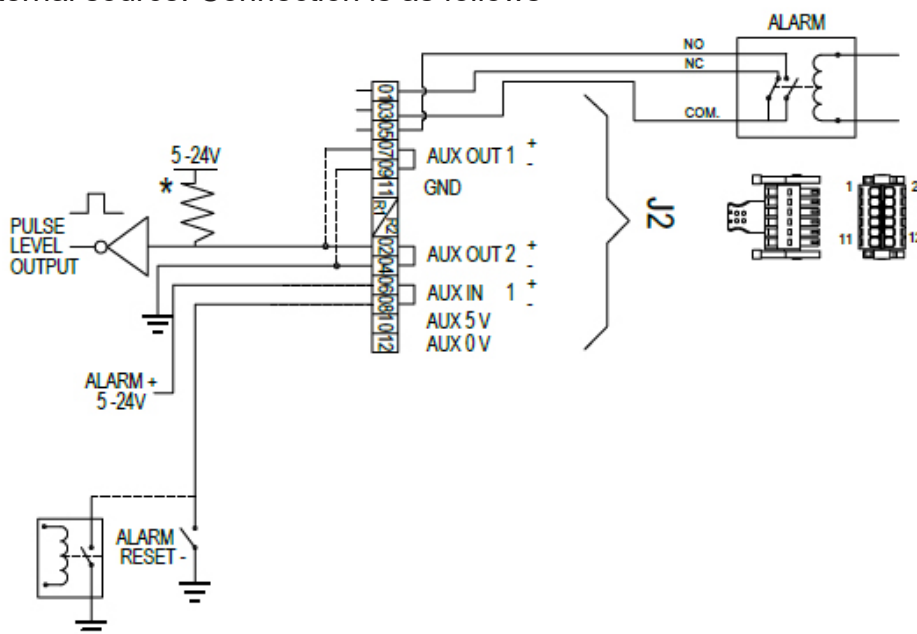

Runtime Screen Setup

The information shown is programmable and can be made to show what the user wishes. It comprises of 5 information's on the right, and 3 on the bottom. These information's can show parameters of the system or parameters being sent into the system from other equipment. These parameters can be made to, after a short time, slide off screen. Touching the screen will make them return.

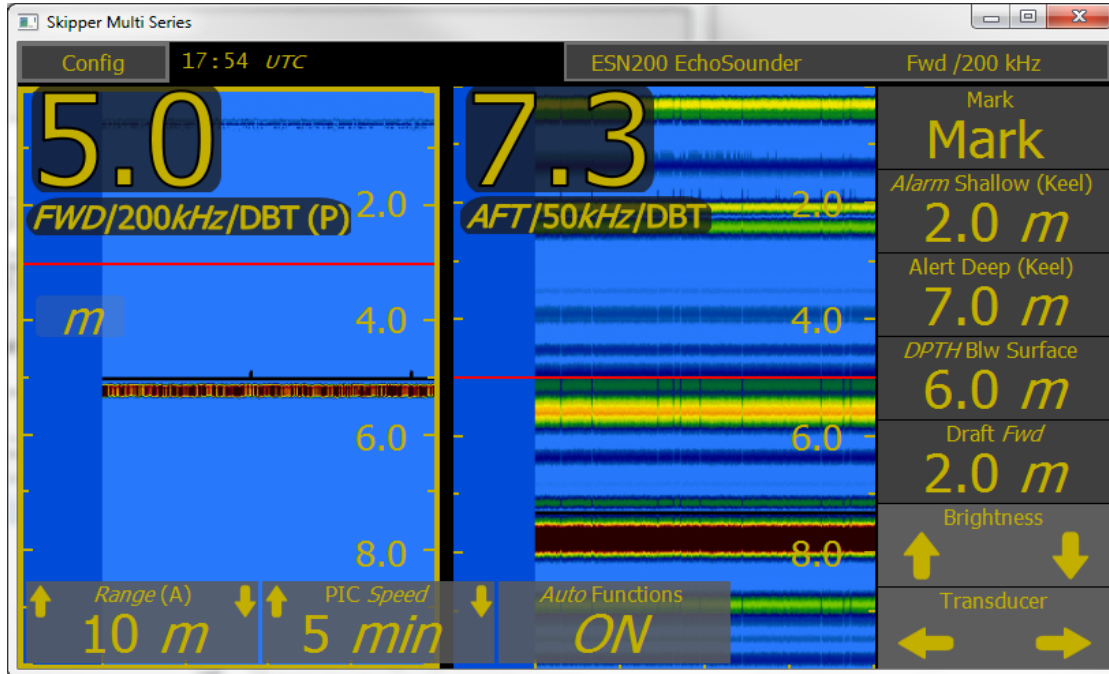

Information 1-5 and Bottom Bar 2-3 are selected by default, but can be changed to show whatever the user chooses.

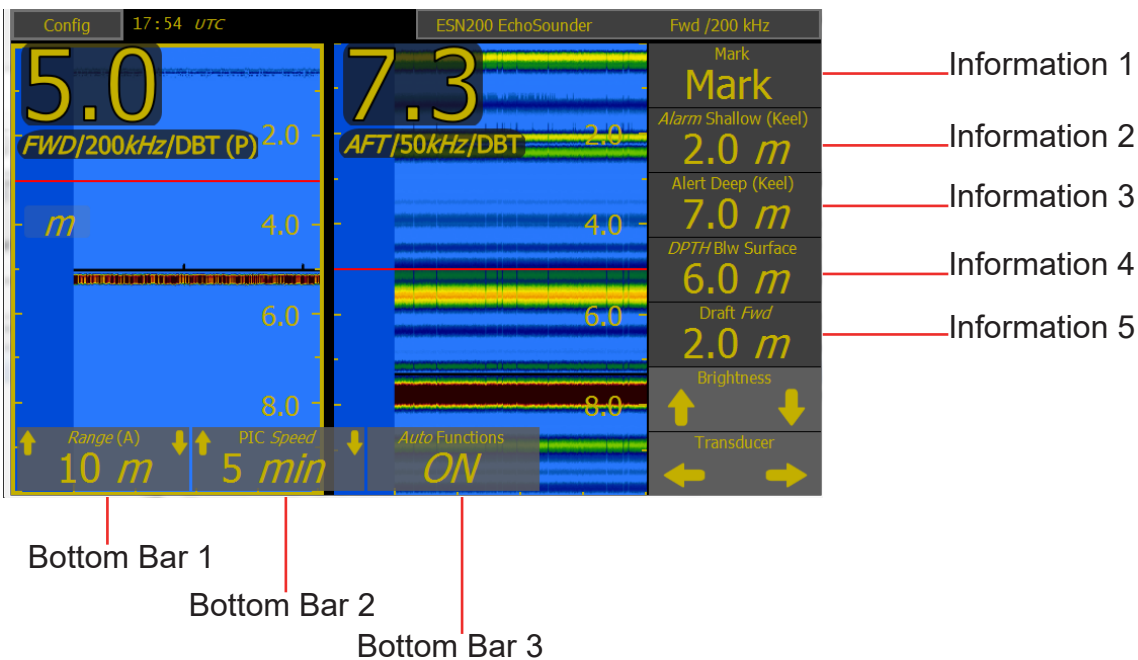

There are 3 “Runtime Screens” to setup.

Transducer 1	The Transducer connected to transducer connector 1 (if this is a dual frequency transducer it will show the low or high frequency)
Transducer 2	The Transducer connected to transducer connector 2 (if this is a dual frequency transducer it will show the low or high frequency)
Both	Show both transducer on the screen (select the transducer with active information by pressing the echogram (a yellow border will show)

To change a value on one of the information bars go to “Config”, “Runtime Screen Setup”, select the transducer screen to be changed and change the information value.

Other information can be shown on the side parameter, these are from the NMEA inputs or from other systems connected via LAN. (e.g. DL2 speed sensor) These include:

Information available are: Dpth below surface, Dpth below keel, dpth below Transducer, SOG from GPS, SOG from log, STW from log, heading, ROT, Depth from log, alarm shallow, alert deep, draft, mark, gain, TVG, pic speed, range, show marks, power, frequency, auto functions, print

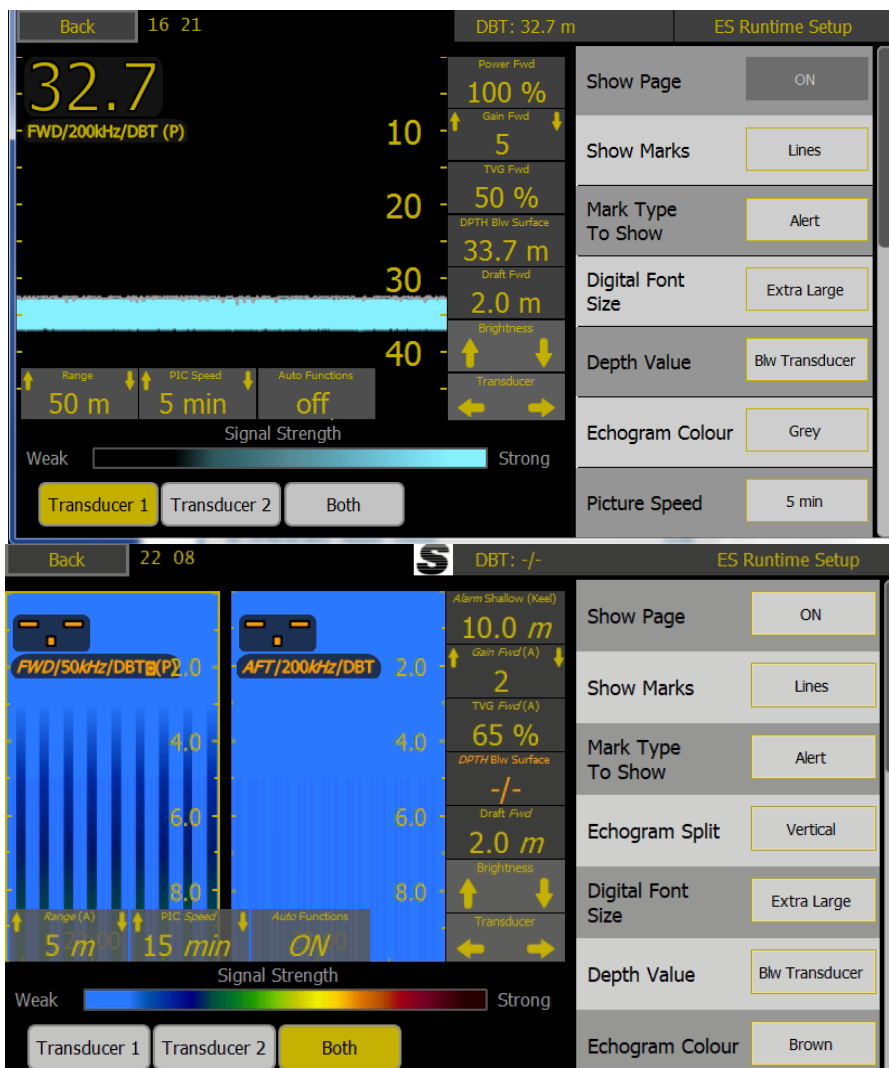

A long (3 second) press will show a menu of the available options. RANGE is always available in the bottom left position with a single touch.

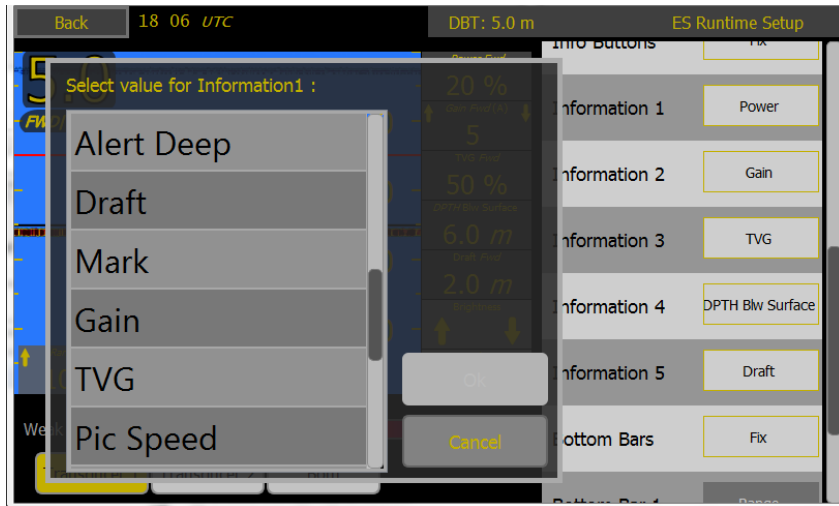

Button	Description
Show page	Activate this transducer display
Show marks	Show changes in the system as vertical line with minimal information (lines, info, full, none)
Mark type to show	Alert / Basic / other / all
Digital Font size	Adjusts the size of the depth text on the left. Small – 1m viewing distance Medium – 3m viewing distance Large – 5m viewing distance
Depth value	The reference point from which the depth is measured (Surface/Transducer/Keel)
Echogram colour	Grey / brown / orange / yellow
Picture speed	The amount of information shown on screen (5mins to 24 hrs)
Info buttons	The information on the right can be made fixed or to disappear after a time, recalled by touching the screen
Information 1-5	Select the information/parameters to be shown on each information. Press to change or press and hold to get all options.
Bottom bars	The information on the bottom can be made fixed or to disappear after a time
Bottom bar 1-3	Select the parameter/ information to be shown on the bottom bar. (1 is fixed to range)

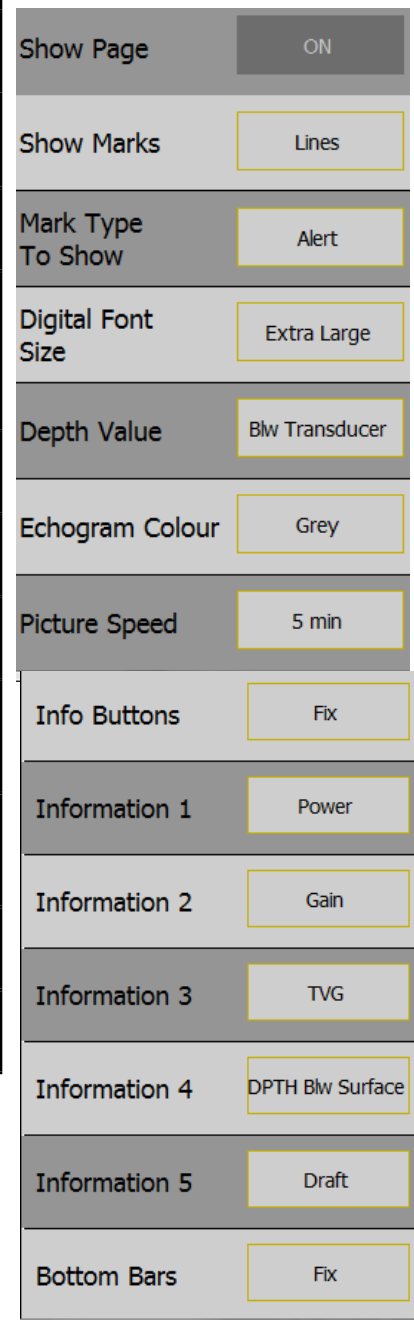

The echogram colour scheme

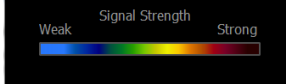
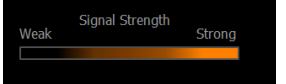
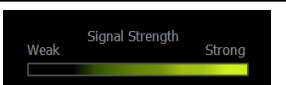
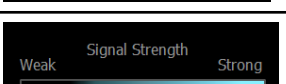
 <p>Weak Signal Strength Strong</p>	Brown
 <p>Weak Signal Strength Strong</p>	Orange
 <p>Weak Signal Strength Strong</p>	Yellow
 <p>Weak Signal Strength Strong</p>	Grey

Changing the colour scheme effects only this dimming theme, dimming themes can also be changed in the remote dimming screen.

Display setup

The Display setup menu gives access to the system parameters the dimming set up and the Network parameters.

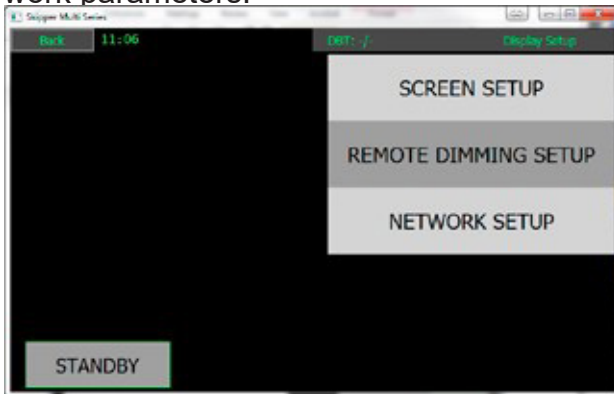

Screen setup

Language: Only English currently available

Alarm sounder: Internal alarm sounder is always on in ALF mode

Button click: Sound feedback on touching the screen

NMEA loop test: Testing of NMEA ports in JB70E2-SA with loop feedback on ports

Sounder test: This will beep at full volume

Calibrate touch screen: Will start touch calibration. If touch screen is totally off then calibration may be initiated by the SKIPPER service software.

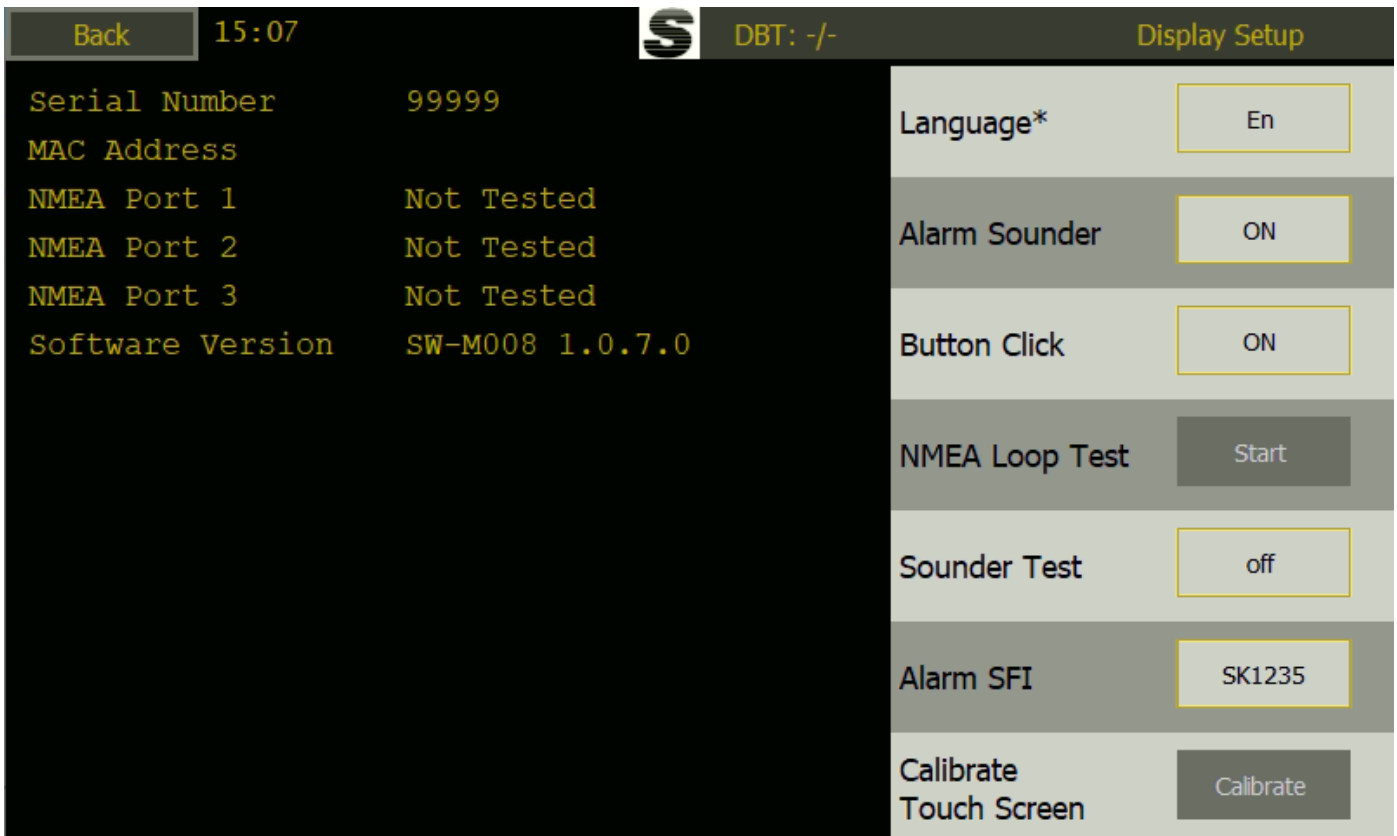

Remote dimming setup

The Dimming levels can be set up on this screen. The user can select dimming and color choices for the 4 preset levels that can be sent remotely (using DDC NMEA command). When the user uses the on screen dimming, the color scheme will change when the dimming level passes the set % value.

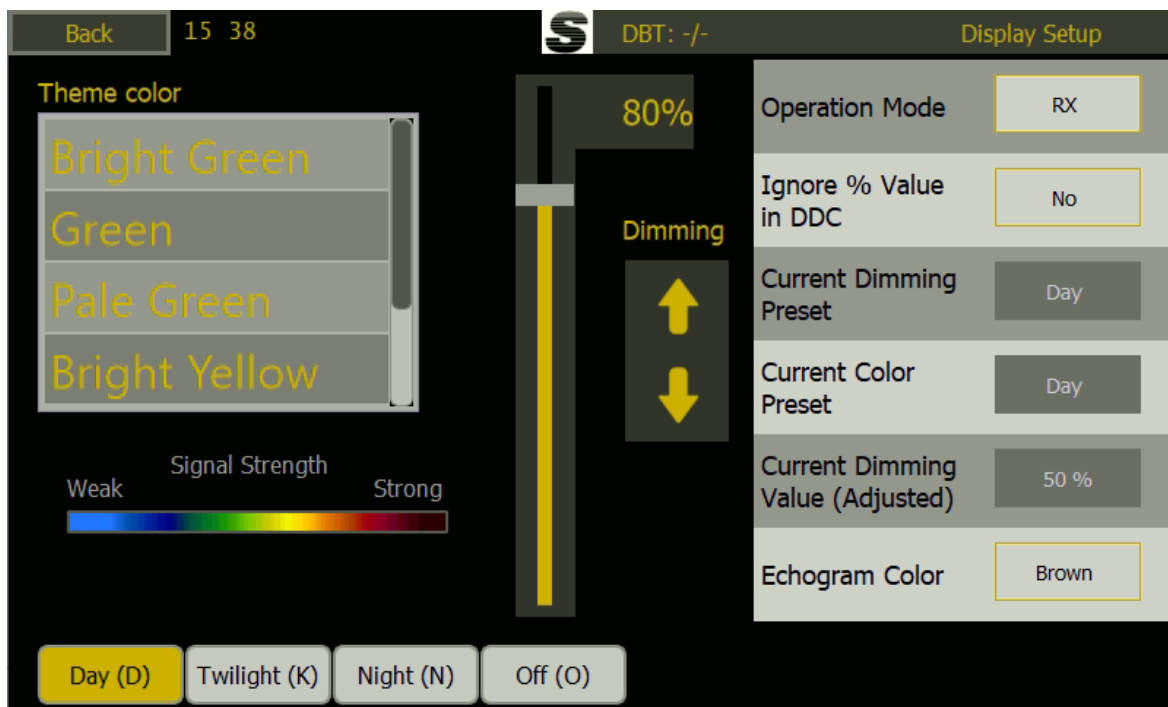



By changing to Day, Twilight, Night , and OFF Text colours can be selected and echogram colour for that level. As the dimming is changed, these colours will change as the dimming level passes through the set level, or if a remote (DDC) command is sent. This allows the user to decide what dimming level is required for this particular display (This may be different in different areas of the Bridge/Control room)

In some cases the remote dimmer may wish to just use the 4 theme levels of Day, twilight, night, off as defined in the DDC part of the IEC61162-1 'NMEA' standard. If there is a % value in this sentence, then this will be used by the system. If however you wish to have a local setting for this, use the button 'ignore %' The system will then use the predefined brightness level set in this configuration

The current dimming settings (whether set by remote or locally), are shown in the greyed out buttons.

Alert setup

There are three levels of alerts:

Alarm		Shallow water	Most critical alert
Warning		Example: Power failure	Less critical alert
Caution		Example: Deep water	Least critical alert

Echosounder “Shallow water” alarm is a safety critical alarm and should be configured such that the user must view the echogram screen to acknowledge a shallow water alarm. This is so that the history of the water getting shallower is seen.

“Shallow water” is classed as a category A alarm. On a dual channel ESN200 the shallow alarm will be triggered when the depth goes from deeper area, passes the alarm limit, on the primary transducer.

If the system is part of an approved INS system with the capability of showing the echogram on other devices, then the system can be classed as Category B. This allows the Alarm to be acknowledged from that system.

The system has an internal alarm sounder, that can be disabled for CAT B usage on the display menu.



The ESN200 can be made to handle alerts using the ALR/ACK protocol or the ALF/ACN/ALC Protocol.

The Protocol is selected on the config – Alert setup page

The system is compliant with 2018 version of IEC62923.

The alerts setup page will allow the alerts to be setup by category, an alert ID number being assigned to the alert, according to the standard. These alerts can be disabled if required.

It is possible for multiple alerts to show, and these will be shown as symbol on the runtime screen, pressing these will give details and pressing '?' on the alert dropdown, will take the user to the diagnostic screen where there may be more information about the cause.

Alerts will be logged in the 24h history and can be seen in the table view or on the history screen using the mark feature.

The alerts will be sent out using the IEC61162-1/NMEA and IEC61162-450 LWE standard sentences. Aggregation is not in use for these sentences.

Responsibility transfer is available on the system failure warning. This means the alert on Serial output will be present slightly before the alert shows on screen.

Power failure alarm:

If the power to the unit fails, this state must be indicated to the bridge in an audible form. If no other method is available, a beeper can be connected to the AUX out (See section AUX setup), and on failure the beeper will sound. In the case of just the JB70 Electronic unit failing the Display will give an alert.

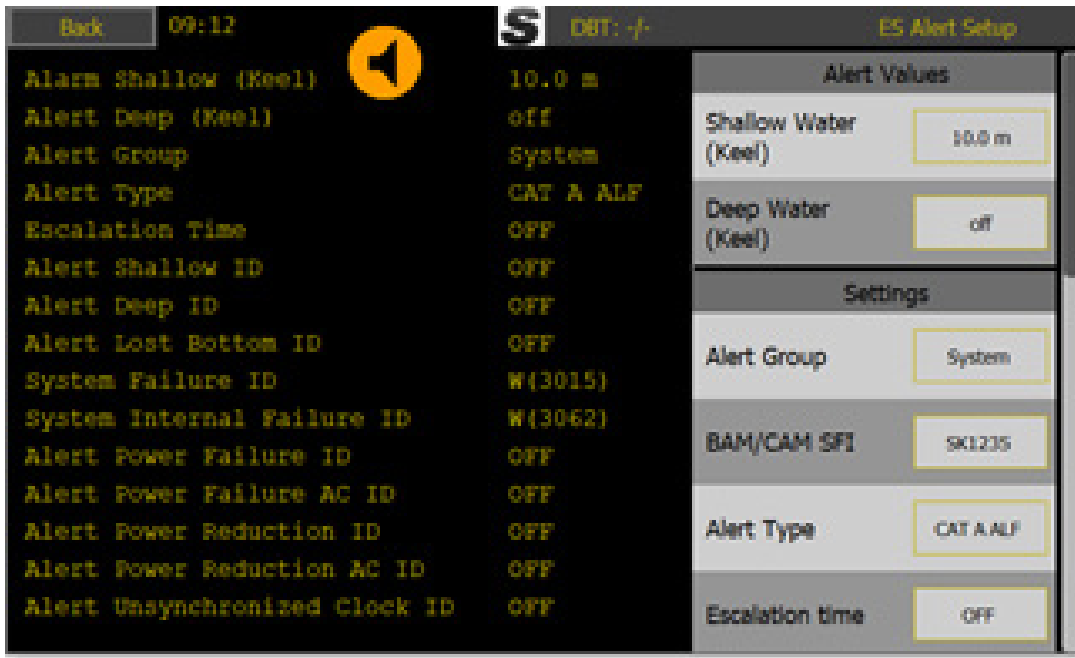

Alert Values

Alert	Range	Default
Shallow water (Keel)	1-99 m	10m
Deep Water (Keel)	2-5000m Can not be less than shallow water alarm	OFF

Settings

Setting	Selection	Default	Description
Alert group	System, CAM1, CAM2, BAM1, BAM2	System	The LWE group for alert messages to be sent on
BAM/CAM SFI	XXYYYY (X is letter Y is number)	CA1235	The Identity of the centralised alarm system
Alert type	ALF, ALR	ALF	The type of alert messages to be sent, ALF or ALR with or without acknowledge of shallow water
Escalation time	1m, 2,3,4,5 m	2 min	If escalation is selected on a warning, this becomes an alarm after this time.

Alarm sentences

\$\$SDALC,01,01,48,0,,,*65
 \$\$SDALC,01,01,49,0,,,*64
 \$\$SDALE,1,1,0,123733.33,B,W,N,,3022,7,2,0,Power Reduction-Display 24V < 22.8V*59
 \$\$SDALE,1,1,1,123733.33,B,W,V,,3022,7,1,0,Power Reduction-Display 24V < 22.8V*43
 \$\$SDALE,1,1,2,123737.37,B,W,N,,3022,6,2,0,Power Failure-Transceiver 24V*31
 \$\$SDALE,1,1,3,123737.37,B,W,U,,3022,7,2,0,Power Reduction-Display 24V < 22.8V*41
 \$\$SDALE,1,1,4,123737.37,B,W,V,,3022,6,1,0,Power Failure-Transceiver 24V*2C
 \$\$SDALE,1,1,5,123737.37,B,W,U,,3022,7,3,0,Power Reduction-System*35
 \$\$SDALC,01,01,50,2,,3022,6,1,,3022,7,3*6D
 \$\$SDALC,01,01,51,2,,3022,6,1,,3022,7,3*6C
 \$\$SDALC,01,01,52,2,,3022,6,1,,3022,7,3*6F
 \$\$SDALE,1,1,6,123805.05,B,W,U,,3022,7,4,0,Power Reduction-Display 24V > 25.2V*42
 \$\$SDALE,1,1,7,123755.55,B,W,U,,3022,6,2,0,Power Failure-Transceiver 24V*2F
 \$\$SDALE,1,1,8,123755.55,B,W,V,,3022,7,5,0,Power Reduction-Display 24V > 25.2V*41
 \$\$SDALE,1,1,9,123757.57,B,W,V,,3022,7,6,0,Power Reduction-System*3F
 \$\$SDALC,01,01,53,2,,3022,6,2,,3022,7,6*68
 \$\$SDALC,01,01,54,2,,3022,6,2,,3022,7,6*6F
 \$\$SDALE,1,1,0,123817.17,B,W,V,,3008,3,1,0,Lost Bottom*37
 \$\$SDALE,1,1,1,123823.23,B,W,V,,3015,4,1,0,Sensor Communication*40
 \$\$SDALC,01,01,55,4,,3008,3,1,,3015,4,1,,3022,6,2,,3022,7,6*63
 \$\$SDALC,01,01,56,4,,3008,3,1,,3015,4,1,,3022,6,2,,3022,7,6*60
 \$\$SDALC,01,01,57,4,,3008,3,1,,3015,4,1,,3022,6,2,,3022,7,6*61
 \$\$SDALC,01,01,58,4,,3008,3,1,,3015,4,1,,3022,6,2,,3022,7,6*6E
 \$\$SDALE,1,1,2,,B,W,U,,3015,4,2,0,Sensor Communication*65
 \$\$SDALE,1,1,3,,B,W,U,,3008,3,2,0,Lost Bottom*12
 \$\$SDALC,01,01,59,4,,3008,3,2,,3015,4,2,,3022,6,2,,3022,7,6*6F
 \$\$SDALE,1,1,4,,B,W,V,,3008,3,3,0,Lost Bottom*17
 \$\$SDALE,1,1,5,,B,C,V,,3119,8,1,0,Unsynchronized Clock*7C
 \$\$SDALE,1,1,6,,B,W,U,,3008,3,4,0,Lost Bottom*11
 \$\$SDALE,1,1,7,,A,A,V,,3031,1,1,0,Shallow Water*17
 \$\$SDALE,1,1,8,,B,W,V,,3008,3,5,0,Lost Bottom*1D
 \$\$SDALC,01,01,60,6,,3031,1,1,,3008,3,5,,3015,4,2,,3022,6,2,,3022,7,6,,3119,8,1*62
 \$\$SDALE,1,1,9,,B,W,U,,3008,3,6,0,Lost Bottom*1C
 \$\$SDALE,1,1,0,,A,A,U,,3031,1,2,0,Shallow Water*10
 \$\$SDALE,1,1,1,,B,W,V,,3032,2,1,0,Deep Water*72
 \$\$SDALC,01,01,61,7,,3031,1,2,,3032,2,1,,3008,3,6,,3015,4,2,,3022,6,2,,3022,7,6,,3119,8,1*63
 \$\$SDALE,1,1,2,,B,W,O,,3022,7,7,0,Power Reduction-System*05
 \$\$SDALC,01,01,62,7,,3031,1,2,,3032,2,1,,3008,3,6,,3015,4,2,,3022,6,2,,3022,7,7,,3119,8,1*61
 \$\$SDARC,,3031,1,A*1A
 \$\$SDARC,,3031,1,O*14
 \$\$SDALE,1,1,3,,B,W,S,,3032,2,2,0,Deep Water*76
 \$\$SDARC,,3031,1,A*1A
 \$\$SDALE,1,1,4,,B,W,A,,3032,2,3,0,Deep Water*62
 \$\$SDALE,1,1,5,,B,W,N,,3008,3,7,0,Lost Bottom*0A
 \$\$SDALE,1,1,6,,B,W,N,,3015,4,3,0,Sensor Communication*7B
 \$\$SDALE,1,1,7,,B,W,N,,3022,6,3,0,Power Failure-Transceiver 24V*1C
 \$\$SDALE,1,1,8,,B,W,A,,3022,7,8,0,Power Reduction-System*0E
 \$\$SDARC,,3119,8,A*18
 \$\$SDALC,01,01,63,4,,3031,1,2,,3032,2,3,,3022,7,8,,3119,8,1*66
 \$\$SDALE,1,1,9,,B,W,V,,3008,3,1,0,Lost Bottom*18
 \$\$SDALE,1,1,0,,B,W,U,,3008,3,2,0,Lost Bottom*11

Alert

All alerts are category B unless otherwise stated.
Responsibility can be transferred on all category B alerts and warnings.

The system will only support 1 instance of each type of alert at a time.

Aggregation is not supported.

The system can be locally or remotely silenced for a period of 30 seconds. After this time the audible signal will return. New alerts that occur during the silenced time will sound even in this period.

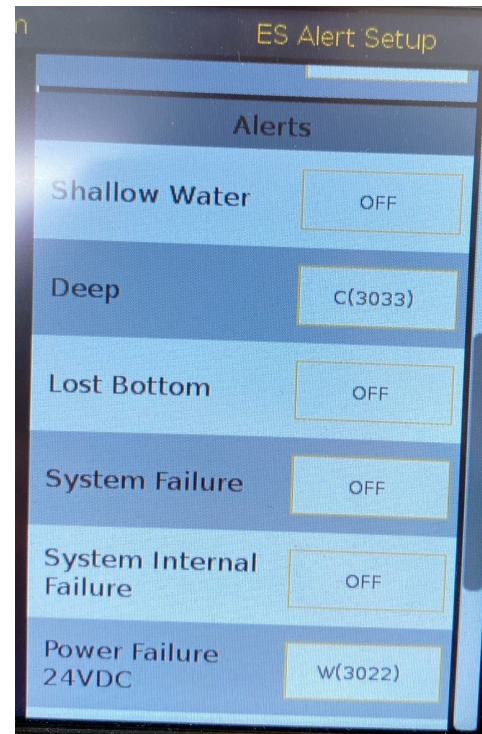

Alert title	Alert message	Description	Alert types selectable	default	Alert ID ALF	Alert ID ALR	Remote Ack
Shallow water	SHALLOW WATER	DEPTH BELOW KEEL <xx M	<ul style="list-style-type: none"> Alarm CatA Alarm CatB 	Alarm CatA	3031	230	<ul style="list-style-type: none"> No Yes
Deep Water	DEEP WATER	DEPTH BELOW KEEL > xx M	<ul style="list-style-type: none"> Caution Warning OFF 	Caution	3033 3032	457	<ul style="list-style-type: none"> No Yes
Lost bottom	LOST BOTTOM	NO DEPTH DETECTED	<ul style="list-style-type: none"> Caution Warning OFF 	OFF	3009 3008	345	<ul style="list-style-type: none"> No Yes
System error	SYSTEM ERROR	SENSOR COMMUNICATIONS or DISPLAY COMMUNICATIONS	<ul style="list-style-type: none"> Caution Warning W-A (Warning with escalation to alarm) Warning OFF 	Warning	3016 3015- 3014	458 457	<ul style="list-style-type: none"> No Yes
System internal failure	INTERNAL ERROR	SETTING DISRUPTING SYSTEM	<ul style="list-style-type: none"> Caution Warning OFF 	OFF	3063 3062	459	<ul style="list-style-type: none"> No Yes

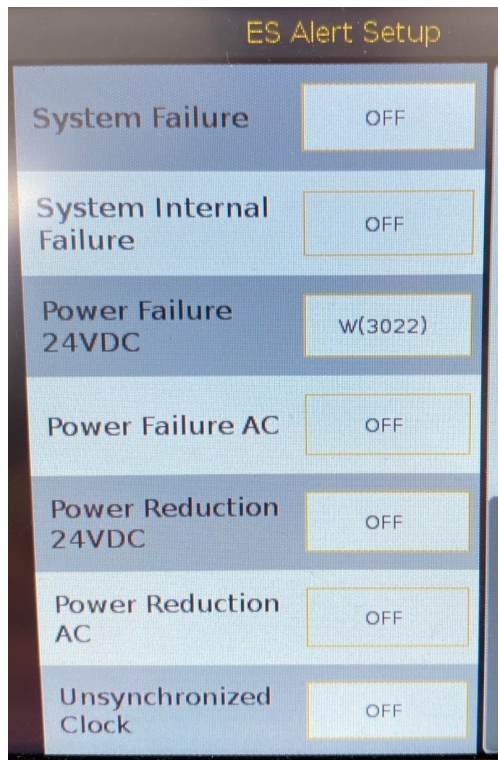

Alert title	Alert message	Description	Alert types selectable	default	Alert ID ALF	Alert ID ALR	Remote Ack
Power failure 24VDC	POWER FAIL	JB70 24V < 12V	• Warning • Off	Off	3022	460	• Yes
Power failure AC	POWER FAIL	JB70 AC MISSING	• Warning • Off	Off	3022	460	• Yes
Power reduction 24VDC	POWER REDUCTION	JB70 24V < 21V JB70 24V >30V	• Warning • Off	Off	3022	460	• Yes
Power reduction AC	POWER REDUCTION	JB70 AC TOO LOW VOLT-AGE	• Warning • Off	Off	3022	460	• Yes
Unsynchronised clock	UNSYNCH CLOCK	NO EXTERNAL CLOCK INPUT	• Caution • Off	Off	3119	119	• No

Explanation of terminology

Alarm shallow	The value at which the alarm sounds as the vessel approaches shallow water
Alert Deep	a second warning or caution sounding if the vessel goes deeper than the specified value - Setting value to zero will deactivate them.
Alert type	<p>The Shallow water alarm is mandatory, but can be used in one of 2 methods</p> <ul style="list-style-type: none"> - CAT A ALF/ACN/ALC: . In this mode no remote status operations are available the system cannot be remotely acknowledged. Remote silencing is available - CAT B ALF/ACN/ALC The system is connected to an approved INS, All remote functions are available <p>Responsibility transfer is available for all alarms and warnings allowing a remote system to take control and acknowledge the system</p>
Escalation type	Escalation is used on all warnings, System Error allows can be configured to escalate to Alarm. The Escalation time can be set. to 1-5 minutes
Silencing	The system can be silenced locally or remotely, the current active alerts will silence for 30 seconds, if a new alert is triggered this will sound within this period.
Clusters	In some installations clusters may be used. This system is to be used in the Nav cluster. This will be indicated on the LAN ALF messages with tag x: and z:

Extra comments:

A number of alerts will provide a second sentence with some diagnostic help, stating which part of the system has the error and what the probable cause is. Further information can be retrieved by pressing the ? on the alert list which will redirect the system to the diagnostics page. Here self test and live values of voltages can be reviewed.

Internal errors are caused by the settings on the system

System failure means the system is not working to specification

Alert states

The Following symbols indicate the current alert status

Symbol Alarm	Symbol warning	Symbol Caution	Alarm/Alert Status	Sound for Shallow water (Alarm)	Sound for other warnings
			Unrectified, unacknowledged	3 beep	2 beep
			Rectified, unacknowledged	No beep	No beep
			Unrectified, acknowledged	No beep	No beep
No symbol			Rectified, acknowledge (Normal)	No beep	No beep
			Silenced alarm	No beep for 30 seconds	No beep for 30 seconds
			Responsibility transferred	No beep	No beep
			Caution	No beep	No beep

If responsibility is transferred, the transferred alarm will remain passive in this system for the escalation time set in config-alert setup screen.

Examples

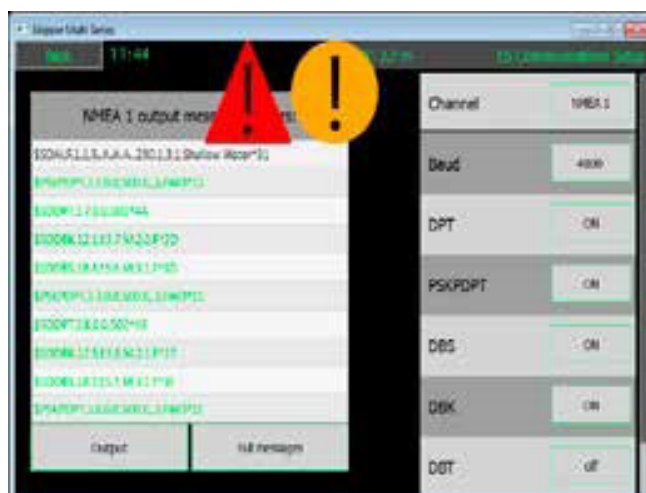

If connected to a central alarm management system, and this fails, the lack of an HBT NMEA message from the CAM will cause the system to take back control.

Diagnostics of alerts

The Skipper service software contains a BAM simulator as part of the Communications /terminal emulator application allowing the user to test, acknowledge and transfer of responsibility, allowing the alerts and their statuses to be shown

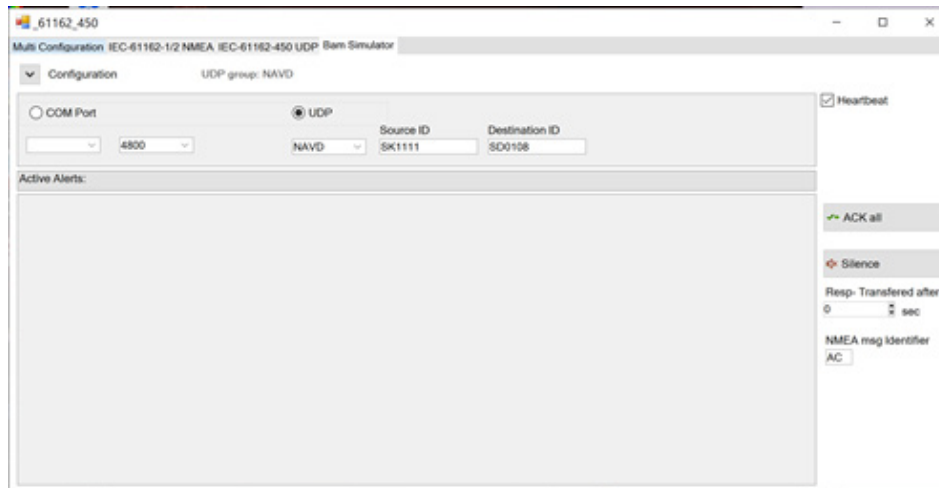

The following shows the NMEA output for an alarm test of all alarms/ warnings / cautions

```

$$$$ALF,2,1,2,,A,A,V,,3031,1,1,0,SHALLOW WATER*11
$$$$ALF,2,2,2,,,,,3031,1,1,0,DEPTH BELOW KEEL < 10 M*3A
$$$$ALF,2,1,3,,B,W,V,,3032,2,1,0,DEEP WATER*53
$$$$ALF,2,2,3,,,,,3032,2,1,0,DEPTH BELOW KEEL > 20 M*3A
$$$$ALF,2,1,4,,B,W,V,,3008,3,1,0,LOST BOTTOM*16
$$$$ALF,2,2,4,,,,,3008,3,1,0,NO DEPTH DETECTED*37
$$$$ALF,2,1,5,,B,W,V,,3015,4,1,0,SYSTEM ERROR*4A
$$$$ALF,2,2,5,,,,,3015,4,1,0,DISPLAY COMMUNICATION*4D
$$$$ALF,2,1,6,,B,W,V,,3062,5,1,0,INTERNAL ERROR*4A
$$$$ALF,2,2,6,,,,,3062,5,1,0,SETTING DISRUPTING SYSTEM*3B
$$$$ALF,2,1,7,,B,W,V,,3022,6,1,0,POWER FAIL*4E
$$$$ALF,2,2,7,,,,,3022,6,1,0,JB70 24V < 12V*65
$$$$ALF,1,1,8,,B,W,V,,3022,7,1,0,POWER REDUCTION 24V*68
$$$$ALF,2,1,9,,B,W,V,,3022,8,1,0,POWER FAIL*4E
$$$$ALF,2,2,9,,,,,3022,8,1,0,JB70 AC MISSING*3A
$$$$ALF,2,1,0,,B,C,V,,3119,10,1,0,UNSYNC CLOCK*6A
$$$$ALF,2,2,0,,,,,3119,10,1,0,NO EXTERNAL CLOCK INPUT*68

```

All the alerts can be sent and handled by a remote CAM/BAM, by pressing the Test Alarms button in the diagnostics screen. An S will show on screen, until this feature is deactivated.

Connection between JB70E2 and Display units

The system is setup to communicate by default. Each unit has an IP address and SFI. These must be different.

IP address: The IEC61162-450 standard allows all private IP ranges, but we recommend use of 172.16.1.X or 192.168.0.X

SFI: This is set default to SD, but the value after this can be changed.

Service software

To change the values of these the skipper service support software can be connected to the system and using the Tools- Com setup option The IP can be changed

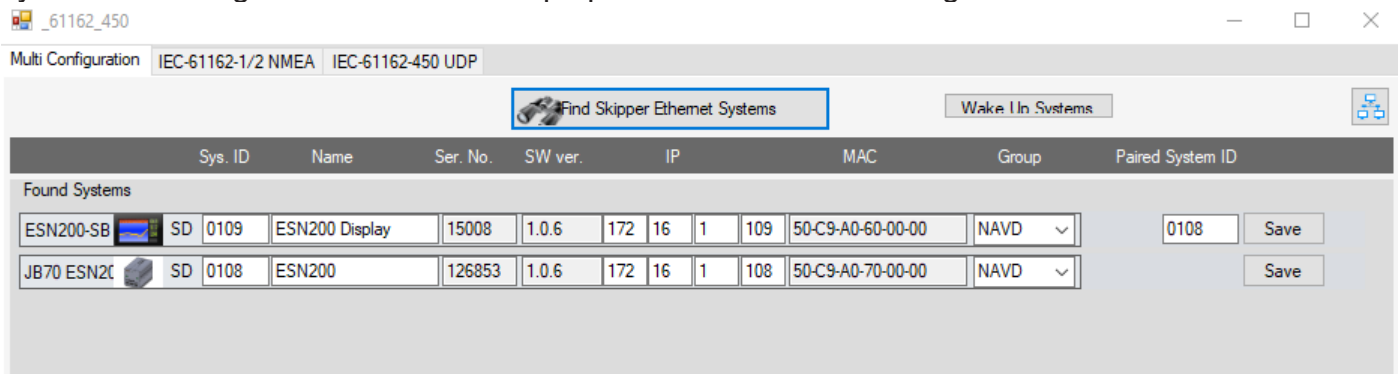

The Connected screens need to be paired to the JB70E2 electronic unit as shown.

These values can also be changed on the screen menu/ Network settings

Display Unit setup – Network settings

<p>The screenshot shows the 'Display Setup' menu with the following settings: IP Address: --/--, Local SFI: SD1237, Paired SFI: SD0106, Group: NAVD. The menu also shows 'Back' and 'DBT: 32.6 m'.</p>	<p>IP: The screen IP can be set up. recommended range is 172.16.1.X , but any private IP address is supported. The IP address must be unique for each unit. The mask is set to 255.255.255.0</p>
<p>Local SFI This is the unique identifier of this display. If more than one display is in use this must be different</p>	
<p>Paired SFI: The display has to be paired to the JB70 Electronic unit, as it is possible to have multiple systems on the same network.</p>	
<p>Transmission Group: The complete system belongs to a group of systems (default NAVD) This can be changed, but all units must be on the same group</p>	

JB70 setup

JB70 unit can only be changed by display if it is already connected.

<p>The screenshot shows the 'JB70 Setup' screen. On the left, system information is listed: IP Address (192.168.0.57), Local SFI (SD0108), Group (NAVD), System Name (ESN200), Serial Number (125861), MAC Address (50-C9-A0-70-00-6E), Software Version (SW-M010 1.0.8.0), Hardware Version (5), Firmware Version (19510), Transceiver Serial (0-0), Internal Logging Memory (0 days), USB Logging Memory (N/A), and SD Logging Memory (184 days). On the right, configuration options are shown with input fields: IP (192.168.0.57), Local SFI (SD0108), Group (NAVD), and System Name (ESN200).</p>	<p>The screen IP can be set up. recommended range is 172.16.1.X , but any private IP address is supported. The IP address must be unique for each unit. The mask is set to 255.255.255.0</p>
	<p>Local SFI This is the unique identifier of this display. If more than one display is in use this must be different</p>
	<p>Transmission Group: The complete system belongs to a group of systems. This can be changed, but all units must be in the same group. Groups available are NAVD(default), RCOM, PROP</p>
	<p>System Name: The name to be reported on the LAN applications</p>

Network setup

The system uses TCP/IP for upgrade, and as default is set to 172.16.1.108 & 109. Subnet mask is set to 255.255.255.0. The system allows use of private IP addresses including the recommended IP addresses according to the standard. If a non recommended IP address is entered, a pop up warning will show, and the colour of the IP address on screen will be orange. Only static addresses can be used.

The system uses the IEC61162-450 (2018) LWE communication standard. This uses a multicast methodology, where NMEA style messages are sent on one of a number of multicast addresses/ports, as specified in the standard. These are called transmission groups, and the natural group for the system is navigation 'NAVD'. Messages are sent using the datagram type UdpBc & RaUdp is used for echogram data. On startup a Identification message (SRP) is sent on the NETA group, dedicated for this as defined in the standard. This information will give the System Function Identifier (SFI), MAC address and the IP address.

This standard requires a unique identifier for this equipment this is called the System Function Identifier (SFI). This is set by default to SD0108/9, but can and should be changed if more than one device on the network. The SFI is made up of 2 letters 'SD' as designated for an echosounder, and 4 digits from 0001 to 9999. This is used to allow the equipment to identify itself to other equipment, and to filter which messages are aimed for this device.

SFI, and IP address can also be adjusted using the SKIPPER service software. UDP messages can also be viewed from this software.

The messages sent can use the following tag blocks as defined in the standard: s:,d:,g:,x:,z:,n:

It is also possible to find which software is loaded in the Display on display.
 Press “Config”, “Display setup”, “Screen setup”

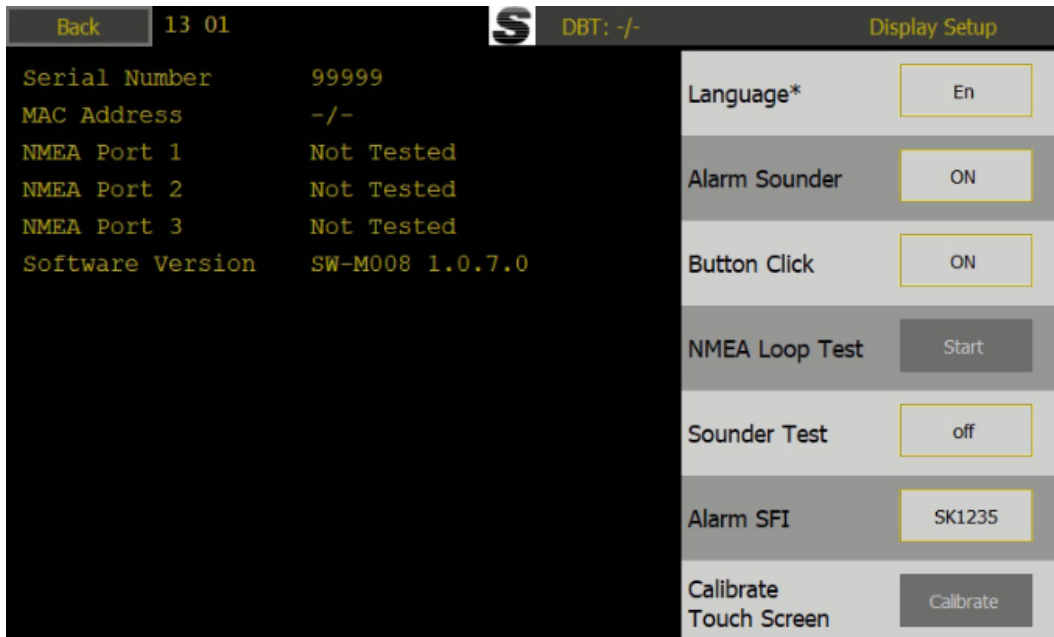

Find software version loaded on the JB70E2 unit
 Press “Config”, “JB70 setup”

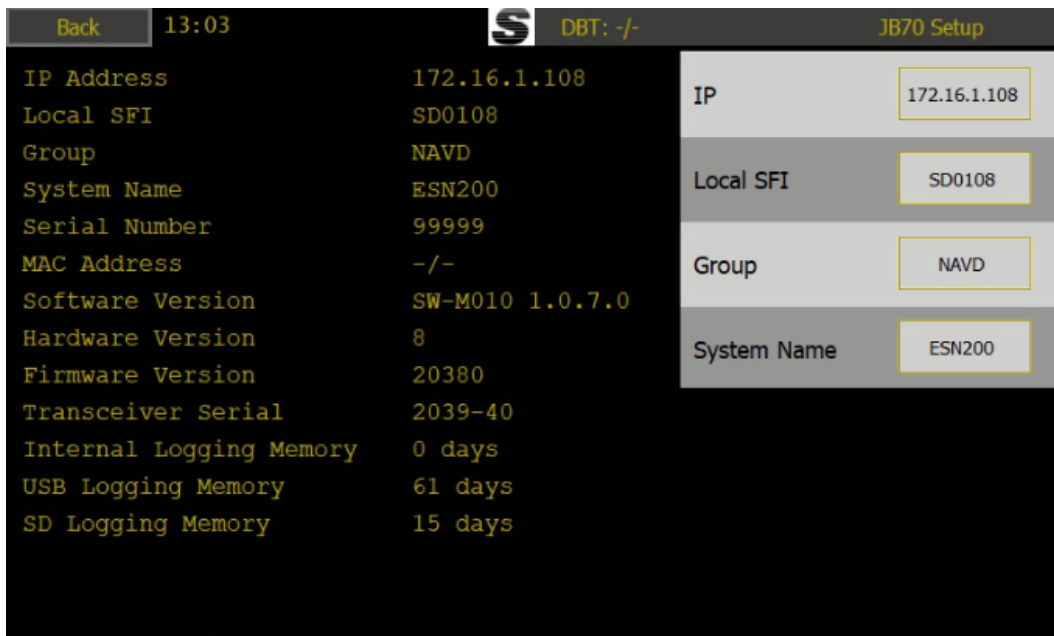

Printing

Printers

EPSON LQ350, OKI ML1190eco or OKI ML280 can be connected to the JB70 USB connector for continuous/page printing.

EPSON TM-T20III Text printer (USB version) is also available to print. Printing Date, Time, FWD AFT and Position.

A pay option is also available to print out GPS status information from up to 2 GPS's connected to NMEA inputs. The text printer allows you to select how often the printout should be activated.

OEM or branded printers is not tested and may not be supported

An information on the screen can be changed to activate printing (from software version 1.0.6)

Date:	27 Aug. '21 UTC	Draft:	Fwd	2.0m
Time DPT	10:32:19	Fwd	5.0m	Aft 5.0m
				LAT/LO 59°53.1 10°48.1
Time GPS1	10:32:20	LAT	59°53.818'E	LON 10°48.1
HDOP	CRS 0.9 45.2	SPD	0.0	Code W84 HT 0.0
Time GPS2	10:32:19	LAT	59°53.818'E	LON 10°48.1
HDOP	CRS 0.9 45.2	SPD	0.0	Code W84 HT 0.0

Setup print button in Runtime Screen

In runtime setup, activate one of the information buttons to Printing. This will show 'On' or 'Off'

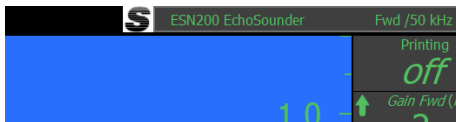

Setup printer type in "Print Setup" menu

The printer is enabled and type selected in "Config", "Print setup".

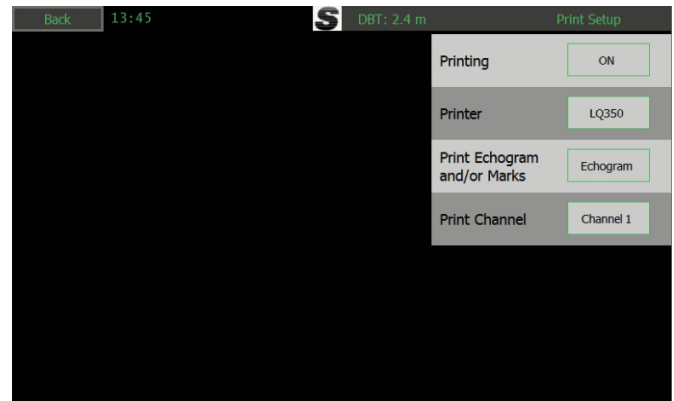
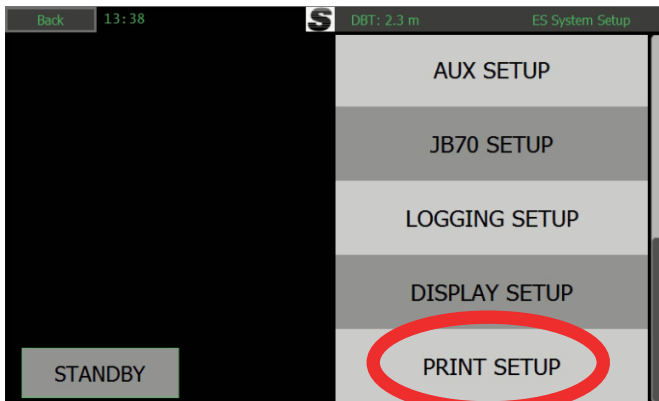

Select Printing "ON", select the correct printer and channel.

Printers: EPSON350, OKI ML280, OKI ML 1190eco, LAN – using service software to print from a local printer, None

Print Echogram and or marks: (Echo/marks(text)/both)

Print channel: Which channel to print (1/2/primary/both)

The printer prints a full page per channel every 15-17 minutes. When turned off, the printer will finish printing the current file before stopping, with slower printers this can take up to 5 minutes. With slow printers we recommend only to print both echograms or 1 channel, not both echograms and both marks files.

To test the printer, turn printing on, a start page will print, then place the system in simulator mode, using the source-'from file' option in diagnostic setup. Then activate the printer, and wait for the printer to print (17 mins).

Connecting the printer

The printer needs to be connected to one of the two USB port in the JB70E2 unit, Some printers may not be electrically isolated from the power, in these cases a USB isolator is supplied , or can be purchased from skipper part EN-USB-ISO

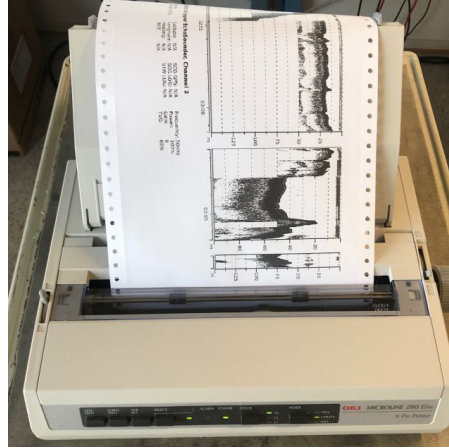
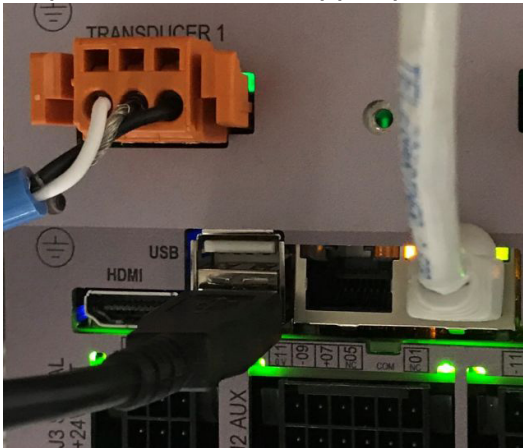

Network printing

An alternative to the above USB printer is to print via Network printer. In this case a PC has to be connected to the network and SKIPPER service software can be used for printing.

PC connection Setup

Features available via JB70E2-SA second ethernet LAN connector to a PC with SKIPPER software:

- Printing to PC printer
- History download
- Software upgrade

The PC ethernet adaptor to be connected to the ESN200 needs to be preconfigured to a unique IP address on the same subnet mask as the ESN200. e.g. 172.16.1.xxx (The Display unit ESN200-SB default IP address is 172.16.1.109 and the electronic unit JB70E2-SA is 172.16.1.108.)

Setting up static IP address in Windows:

- 1: Click Start menu > Control panel > Network and sharing center or Network and internet > Network and sharing center.
- 2: Click change adaptor settings.
- 3: Right click on local area connection.
- 4: Click properties.
- 5: Select Internet protocol version 4 (TCP/IPv4)
- 6: Click properties.
- 7: Select Use the following IP address

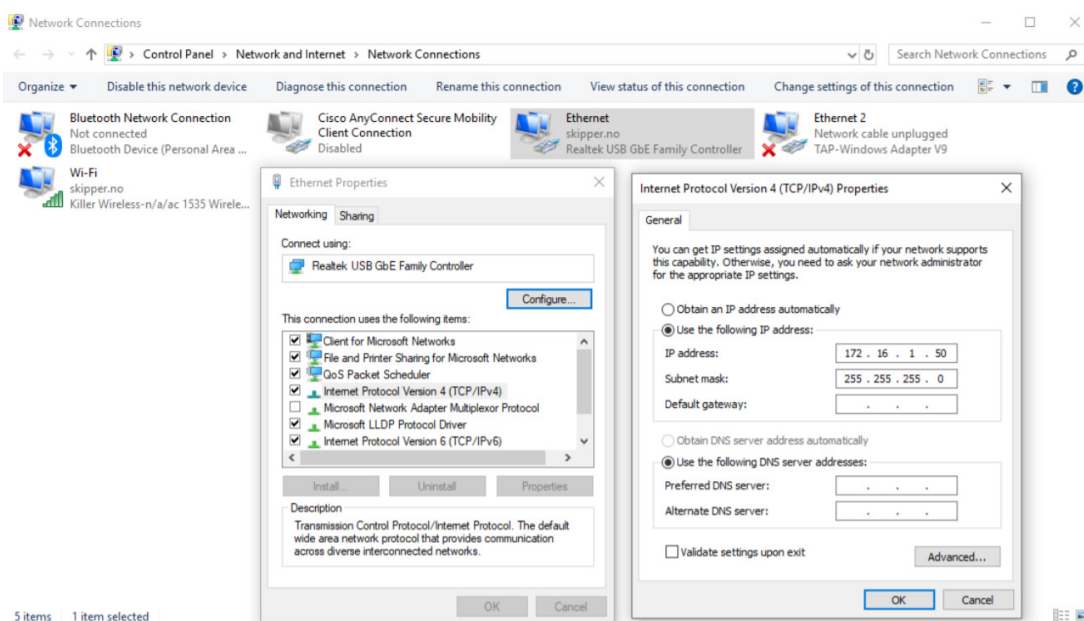

The ESN Printing app is installed with the service software and a shortcut can be made to it in folder C:/Skipper/servicesoftware/esnprinter.exe

Upgrading software

Both Display and JB70 unit have their own software. It is always wise (and often required) to upgrade both units if software is to be upgraded. To do this the skipper service software is used. Selecting the ESN200 app, will allow you to search for the units, and then upgrade using a file downloaded from www.skipper.no, or sent from your service hub. JB70E2-SA uses software SW-M010, ESN200-SB Display uses software SW-M008. These softwares are in a compressed format .tar and should not be decompressed before loading.

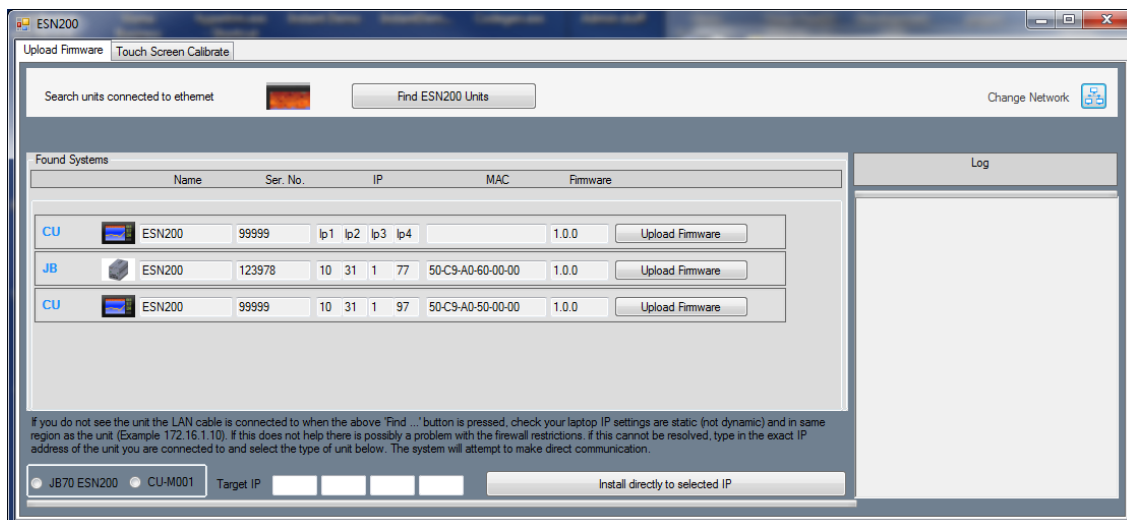

USER Information

Introduction

The ESN 200 Echosounder system is an echosounder with 2 channels that can be switched between frequencies and transducers.

The Screen can be setup to show the parameters that the user wishes to see or control, but it also has an automatic function that takes over the control of range, gain, frequency and power of the system to minimize the required amount of user interaction.

The system has 1 mandatory alarm (Shallow water) and a second deep water alert. In addition it gives alerts of system failures.

The system will have 1 or 2 transducers installed, typically 50 kHz in the bow and 200kHz aft. With this system it is also possible to install any of 8 frequency transducer both forward and aft and if dual frequency transducers are used, the system can be made to select the best frequency at any particular time.

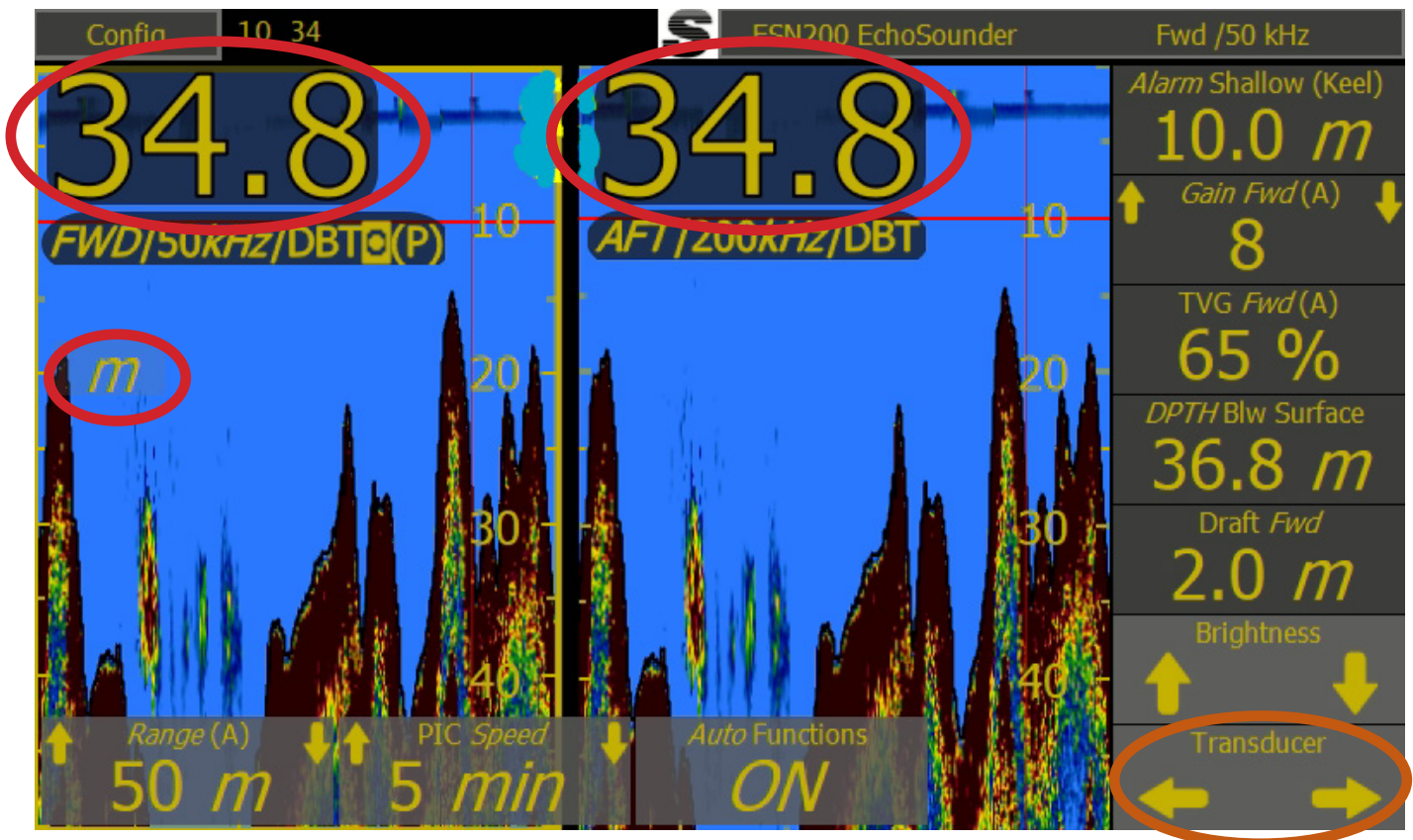

Single Channel or Dual channel screen (orange circle)

The transducer selector can switch between Transducer 1, Transducer 2 and Dual transducer screen..

Depth and units (red circle)

For each channel the Depth is shown numerically on the left. The Echogram shows the graphical variation of depth over time.

The units can be changed by touching the unit sign, or in "Config", "ES Setup", "Main Setup".



Transducer info:
 Position: Fwd
 Frequency: 50 kHz
 (P)=Primary transducer. Transducer for NMEA Out and Alarm
 These settings can be changed in:
 "Config", "ES Setup", "Transducer Setup"

Depth info:
 DBT (Depth Below Transducer)
 These settings can be changed in:
 "Config", "Runtime Setup"

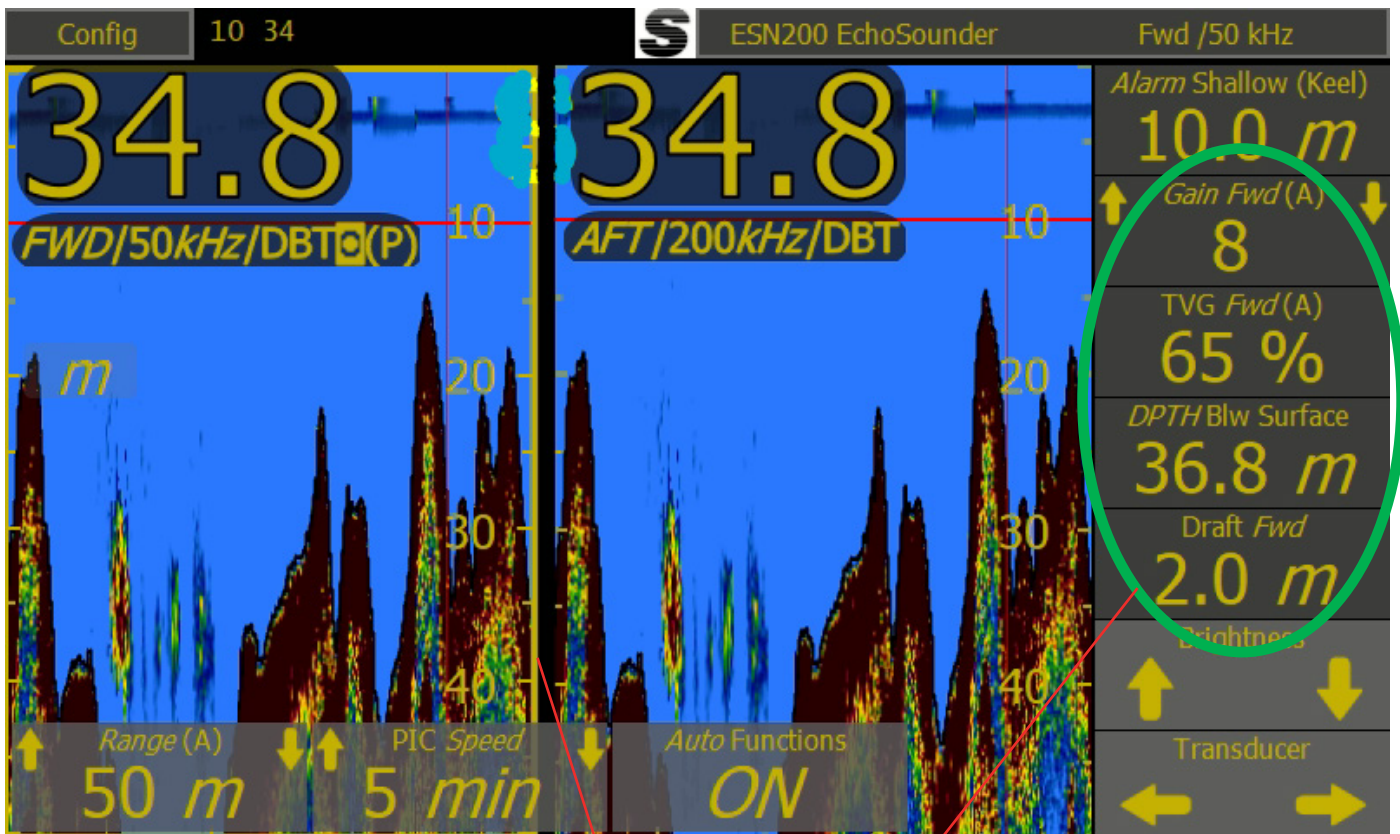

The settings of transducers in the right panel (green circle) is valid for the "Yellow highlighted" channel.(In this example it is the Fwd 50 kHz primary transducer.)
 Change the highlighted channel by touching the area of the other channel.

Auto Functions

When the “Auto functions” are ON then the system will change the range, gain, TVG, power and Frequency (If transducer is dual 50/200 kHz) automatically, as the depth changes.

The user can take control of the auto parameters by setting “Auto functions OFF”. The system will inform that it is taken out of Auto mode and the user then has full control. The system can again be put into auto mode using on screen button (if selected), by pressing and holding a parameter, or within the menus.

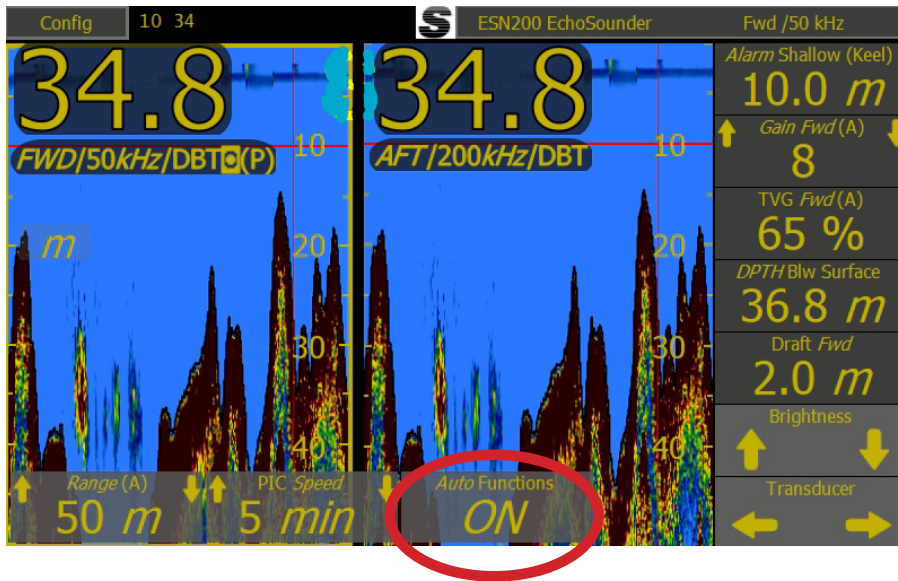

Manual mode

In Manual mode, the user will typically be required to control the Range, and gain of the system, although it is also possible to control the power and time variable gain (TVG) to give a clearer picture. When in auto off mode the top 3 right side information's Will show power, Gain and TVG.

The system can be made to show the information/ options, or to hide it until the user touches the screen. (in Runtime screens)

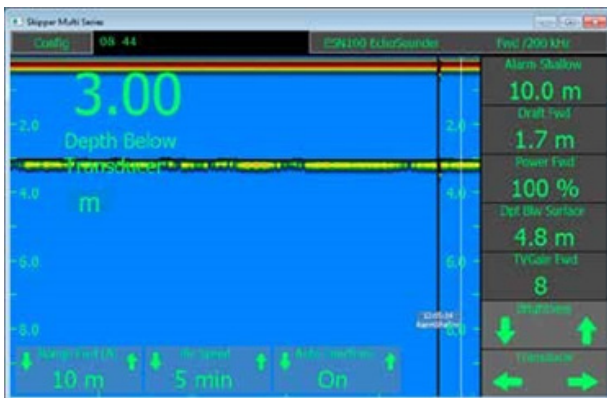

Selectable Information

All the buttons on the side and bottom can be selected (Except Range which is permanent) And this information can be made to disappear after a short time (selection made in menu 'Runtime screen setup' using option Info buttons, or bottom bar: fix or slide). The information/options can be recalled by touching the screen



Screen Configuration



The main screen can be set up to show numerous informations on the right and below the screen Buttons on the information and bottom bar can be adjusted to show the information the user required in the runtime setup.



Press and hold the button to see all the choices.

Press on the config button and runtime setup to access the general screen information options

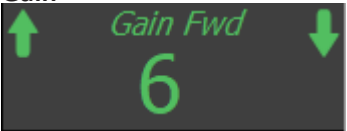
All button functions are available in the menus, so if a button is selected away, it can be accessed from the config menus.

Main adjustable features are:

<p>Range</p> 	<p>Range is always available within a single press of the screen on the bottom left corner.</p> <p>Manual Range can be set in 50m steps from 5m to the maximum the installed transducer can detect. Smaller steps are available below 50m.</p> <p>Auto: In this mode the range will change based on the digital readout of the system. Auto range is part of the full range of auto functions and will cause other functions to become auto as well</p> <p><i>The value can be changed by pressing</i></p>
<p>Gain</p> 	<p>Gain is the amount the signal, reflected from the bottom, is amplified. This should be adjusted such that the signal strongly visible at the bottom and below, but not above the bottom.</p> <p>Manual : Gain can be adjusted between 1 and 12 and is most effective for areas deeper than 50m</p> <p>Auto: Auto gain will, combined with TVG and range adjust to give the most signal.</p> <p><i>If not on screen this is available in menu ES Setup</i></p> <p><i>The value can be changed by pressing and holding</i></p>
<p>TVG</p> 	<p>Time variable gain Predicts how much the sound will fades in the water , and compensates.</p> <p>Manual adjusting this will give stronger/weaker signal near the surface, and can be used to reduce strong fish or bubble layers</p> <p>Auto : This function works together with gain to provide an acceptable picture and continuous bottom detection.</p> <p><i>If not on screen this is available in menu ES Setup</i></p> <p><i>The value can be changed by pressing and holding</i></p>

<p>Pic speed</p> 	<p>Picture speed selects the speed at which the bottom will move across the screen. Units are the time to refresh the whole screen. A scale can be seen at the bottom of the screen.</p> <p><i>If not on screen this is available in menu Runtime setup</i></p> <p>The value can be changed by pressing and holding</p>
<p>Alarm shallow</p> 	<p>The Shallow water alarm is obligatory, and is indicated on screen by a red horizontal line. When the depth is shallower than this the alarm will sound. And an indication will show on the screen. Depending on the system configuration the system may require acknowledgement on the control unit, or may allow remote acknowledgement.</p> <p><i>If not on screen this is available in menu Alarms</i></p> <p>The value can be changed by pressing and holding</p>

A vertical mark will be made on the screen when this option is active, when an important setting is changed, or an alarm/alert is sounded. This mark will also be stored in the saved depth logs. If GPS is connected the time and position will be recorded.

If not on screen this is available in menu Runtime setup

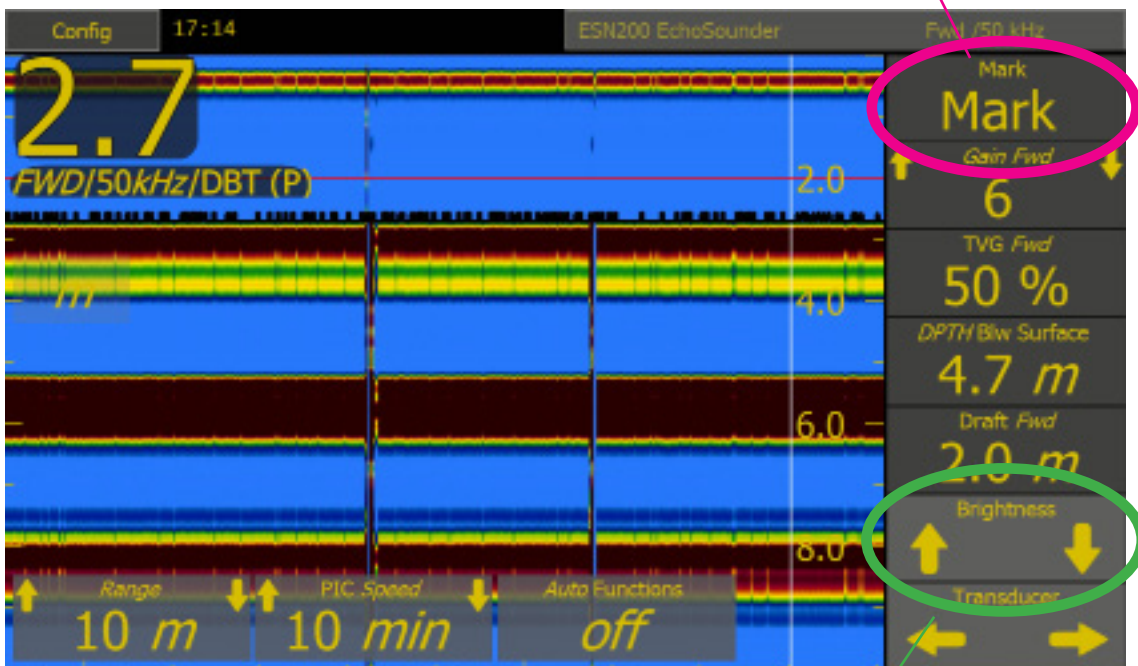

Dimming up and down is available using the up and down arrows, or the slider that pops up when a dimming arrow is touched. IF the system is dimmed too far down, press and hold the screen, and it will return to a 'visible level'.

The screen will not dim fully down if an alarm is active. If an alarm becomes active when fully dimmed, the screen will return to the 'visible level'. And return after acknowledgement

This is always available, but can be adjusted in Display setup

The position and frequency of the currently active transducer is displayed on the top banner

If dual frequency transducers are installed then the frequency button will allow the user to change between the available frequencies.

Manual: 50kHz / 200kHz

AUTO: The system will change frequency at a predefined depth. Default 0-200m 200kHz, below 200m 50kHz

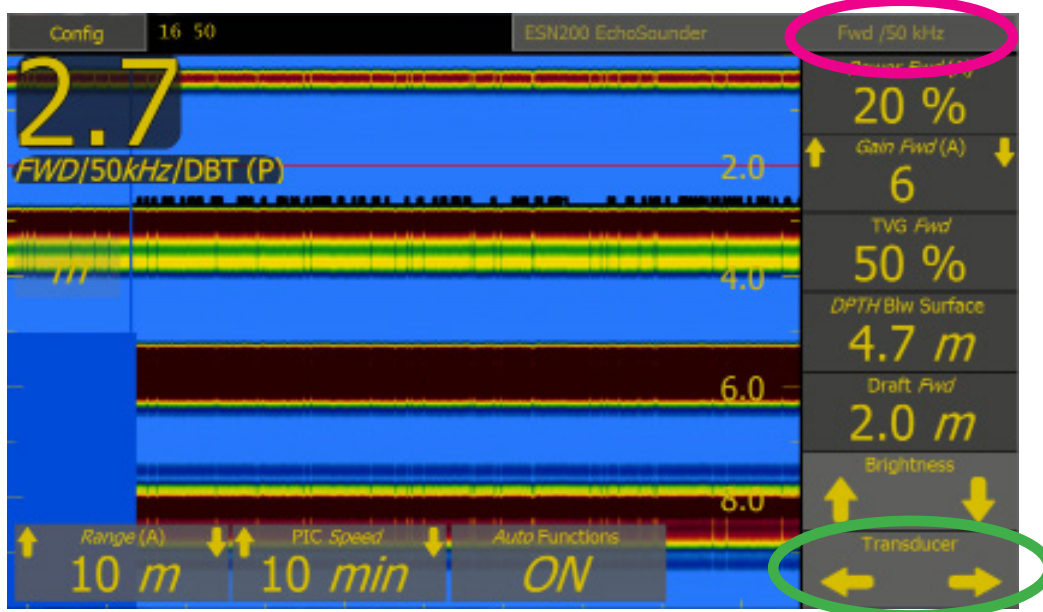

The left right button will allow the user to change the transducer displayed. Each of these may have up to 2 frequencies.

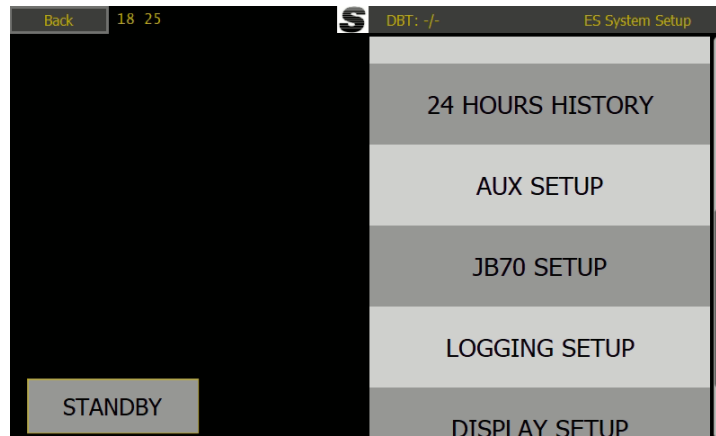

24 Hours History

The ESN200 is automatically saving the last 24 hours of depth recording, including the relevant input s such as GPS, Heading, other depth measurements.

24 Hours history is available by pressing “CONFIG”, and then “24 Hours history”

By selecting table, the depth of at least every minute and marks in between (indicating changes or highlighted events such as alarms or auto changes) are listed with time and position, if available. This can be viewed on the history page as a picture or table. It is possible to view all changes made manually or automatically by the system, all alarms and acknowledges, or just depth and position data.



Show marks, On the graphic display show a vertical line and information when something changes (Full, none, lines, info, alarms)
Mark type to show: Alr and Man: Alarms and manual marks Basic, all changes shown as 1 letter G=gain, P=power,R=range,M=mark Other, just manual changes All, All changes
Range: Range to show on history screen
Show Channel: Which channel to show on screen (1/2)

Extended logging of history

In addition to the obligatory 24 hours logging, that can be viewed on the 'Show History screen' Logging to file can be activated in the 'logging setup' (picture). Here the system values can be logged internally or externally to disk (SD or USB) when logging the LED under the SD disk will light.

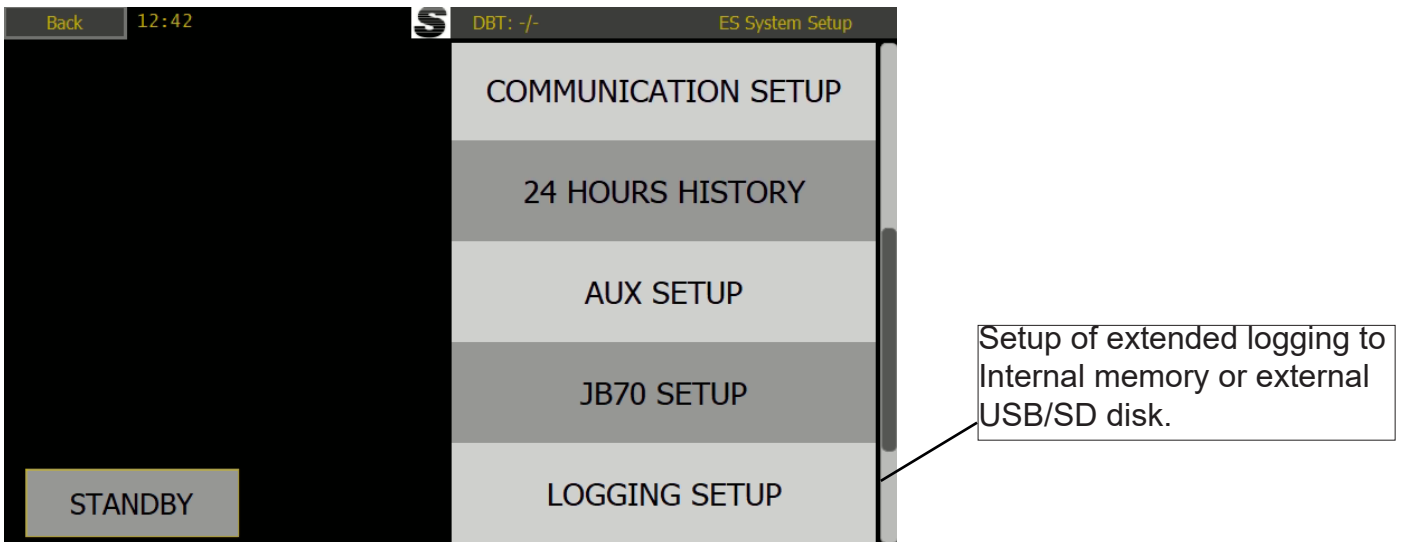

Saving to disk

Both the USB and SD disks can be used to save data. Insert the disk and select the data you wish to log in the Logging setup menu. This can be processed in the service software. Depending on what is input to the system, or selected to be logged, the system logs up to 4MB per 24 hours.

Each completed echogram is converted to a PDF file and can be extracted using the service software on a separate PC via LAN.

Logging to file can log all depth history in different formats and all NMEA input and output history.

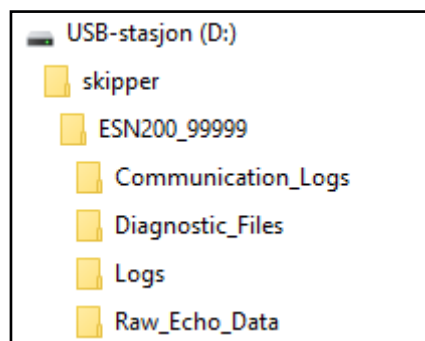
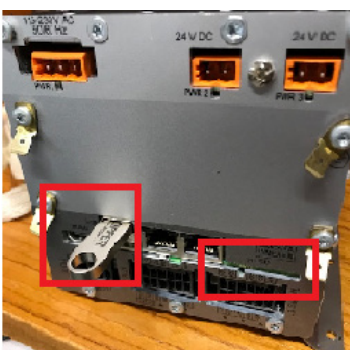

Example of file structure of USB memory



Setup of depth history and communication history (NMEA+LAN)

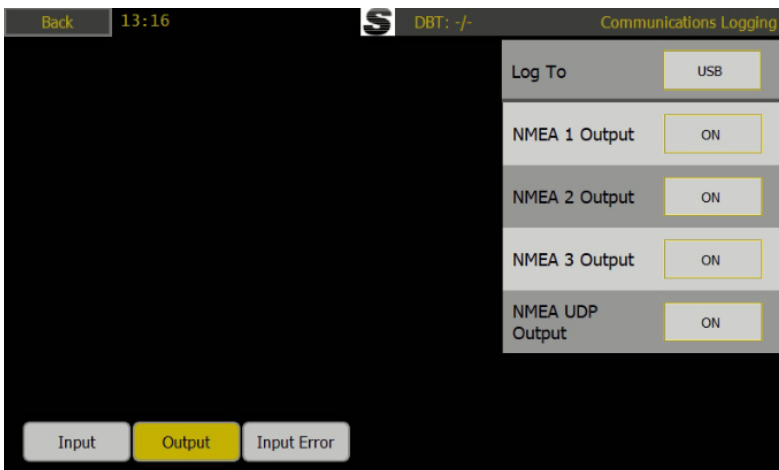

Setup for additional logging of NMEA and/or NMEA UDP to disk

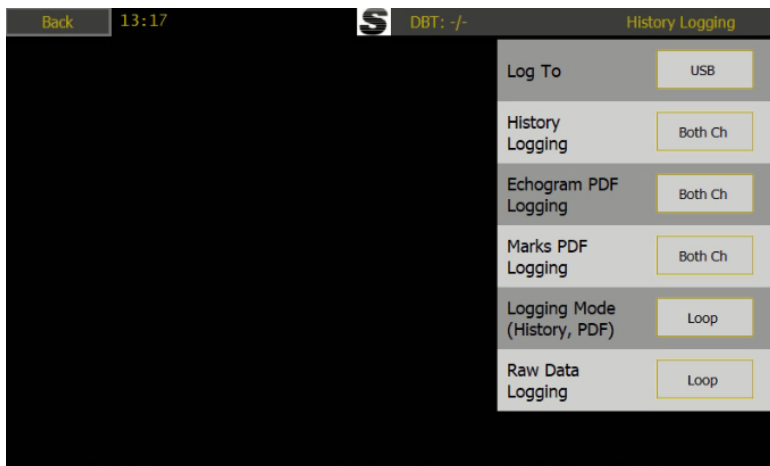

Log to: Selection of the media to log to, (SD, USB, Internal)

History logging: Which channel to log (1/2/both)

Echogram PDF logging: Save echogram and data to pdf (none/1/2/both)

Marks PDF Logging: Which channel to record the system changes on (none/1/2/both)

Logging mode: extended logging until the selected disk is full, and then the system will loop or stop

Raw Data Logging: If raw data is selected, all relevant data will be logged, again until the disk is full or the system will loop overwriting the oldest data.

Diagnostics

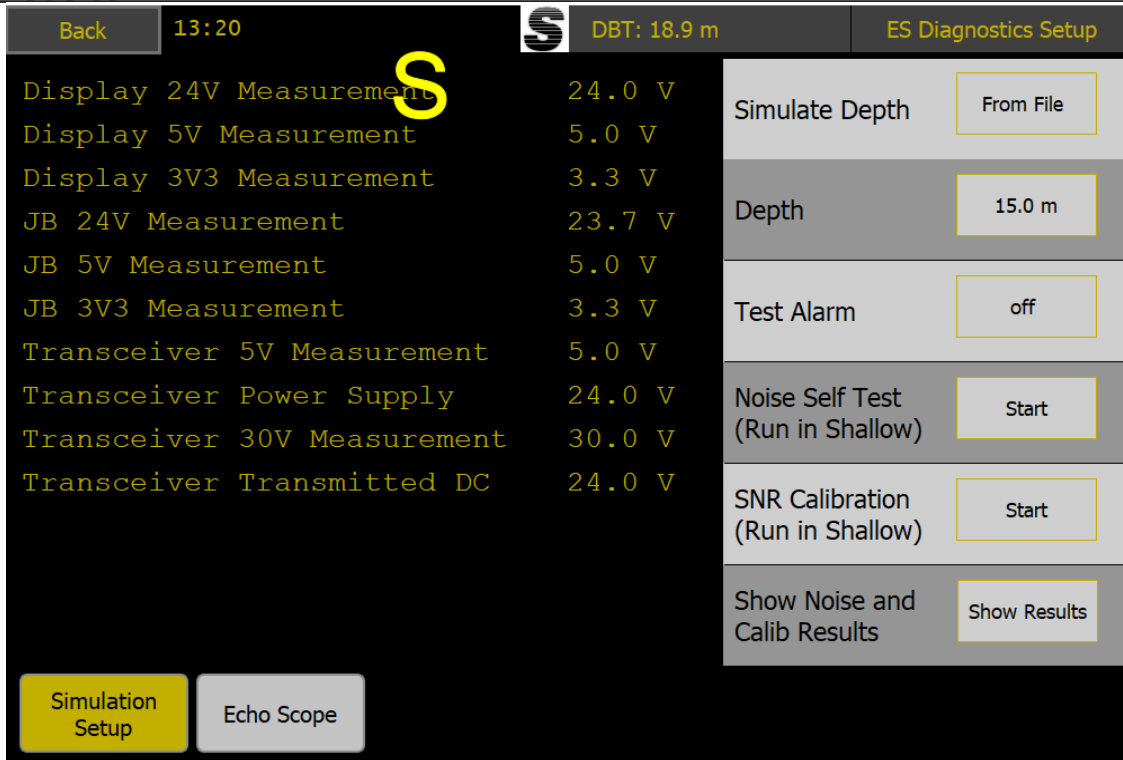

The ESN200 has a number of functions to allow the user to simulate, diagnose and optimise the system.

The Diagnostics setup will help identify the problem.

Parameter	Description
Simulate depth	Make a depth of the desired value (Depth button) To test outputs and alarms, alternatively have a moving depth , or run a simulation from file.
Depth	The value to be sent, or the value the moving depth will move above and below.
Test alarm	Send all known alarms to the output. (These can be acknowledged/ silenced/ changed as a normal alarm/alert)
Noise self test	Run this to check the Noise levels of the system
SNR Calibration	Run this calibration to tune the system once installed in the vessel
Show Noise results	Show the results of the noise test (See below)

Noise self test will run a series of pings and measurement within the system to find the noise conditions. These can be inspected by pressing the show noise button

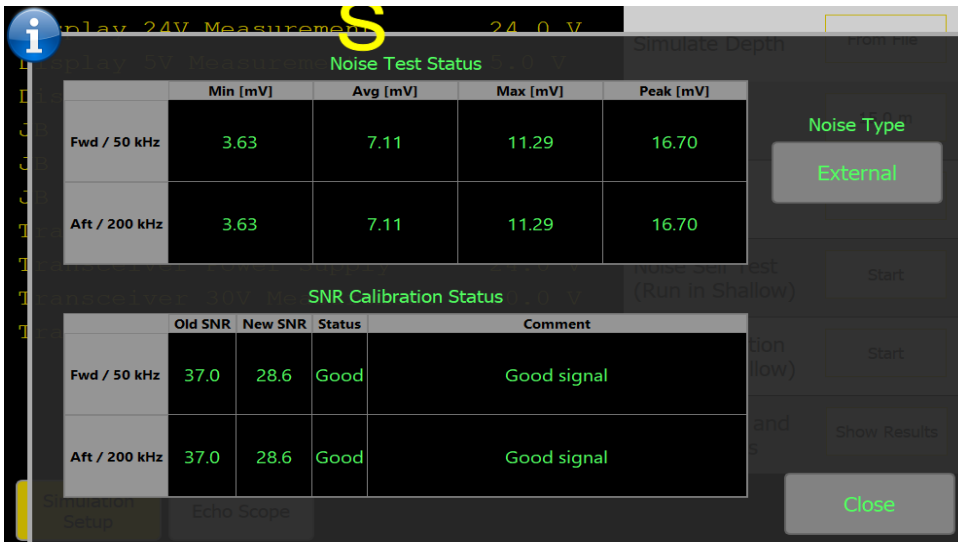

The values shown should be below 20mV once installed unless otherwise stated. High values can usually be reduced by improved cabling and / or filters on the power supply.

Once installed, the mounting of the system can cause some changes from the default setup. This can have an effect on the auto functions. To improve this the SNR calibration can be performed and the system will optimise itself.

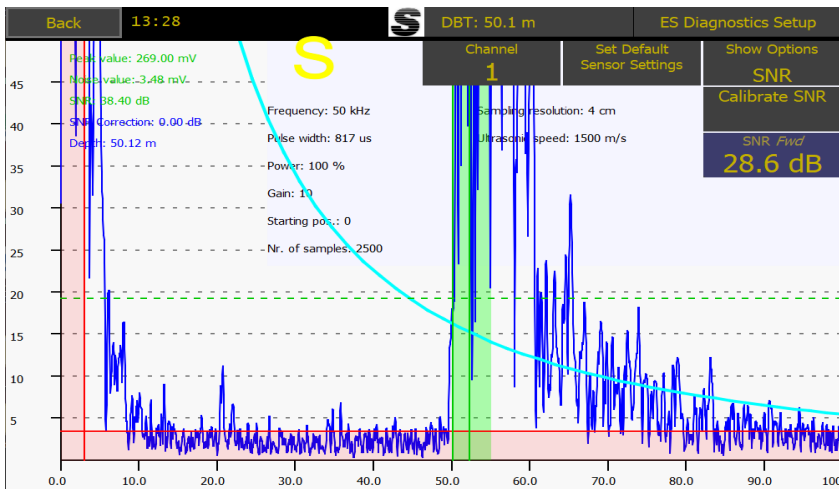

Each ping is plotted in the Scope screen

Here you can see the pings and the parameters in use to detect it, The green zone is showing the detected depth , the red zones are areas where the bottom detection will not have an effect. this is typically at low signal levels and in the ringing period after the system sends a pulse.

LED indicators are as follows

Status 1 (Green) flashes on detected bottom (either channel)

Status 1 (Green) Solid - sensor muted

Status 2 (Yellow) flashes on lost bottom

Status 2 (Yellow) solid if problem with transceiver. (comms to sensor not working)



Transducer 1 og 2 flashes when the system pings

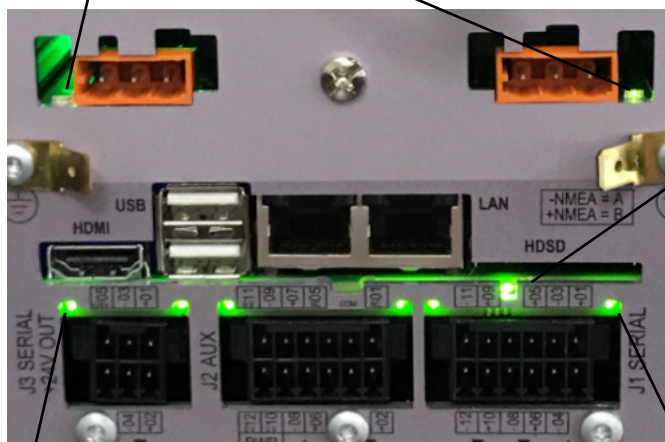

-LD21 off - logging history to internal memory,
 -LD21 always on - logging history to USB or SD, and the device is present and has free space.
 -LD21 flashing at 1 Hz - Logging history to USB or SD, and the device is either not present or it is full.

From left
 LD 5 24V Sensor power out on / off
 LD 4 5V output power J3 (NMEA 3/Sensor)
 LD 6 input on AUX
 LD 3 NMEA input on J3 (sensor)
 LD2 Input on NMEA 2
 LD 1 Input on NMEA 1

Lost bottom or input information

If the system cannot locate the sea bed, for a period of time it will go into lost bottom mode. This is normal once it is too deep (depending on transducer frequency and sea/sailing situation) This will normally occur if there is lots of air under the transducer (sailing aft, being tugged or use of thrusters in shallow water) it can also occur if the water is very dirty, blocking the sound, or the sea bed is very absorbent (very soft mud)

In this situation the depth number will disappear from both the display and outputs. In its place on screen the following symbol will be shown -.-

If the information panels are set to show input parameters these will also show -.- if there is no, or invalid information on these inputs.

If the system is in AUTO mode the system will start changing parameters every few seconds to try to refind the bottom. In this case the displayed echogram range will lock until the bottom is refound, but the Range value, gain and power will change every few seconds

Diagnostics of the ESN200 using an ETT985

The ETT985 echosounder and transducer tester has been updated with tests for the ESN200 echosounder and the new transducers ETS50200 and Furuno 8B-200B. These updates can be downloaded from the skipper website when the ETT software is started.

Connecting the ETT985 to the transducer ports of the JB70E2-SA unit and then running the ESN200 noise test for the appropriate frequency will allow the user or service technician to check the signal output and noise characteristics of the system.

Using the transducer tester, the connected transducers can be analysed to see if their resonance impedance is as expected.

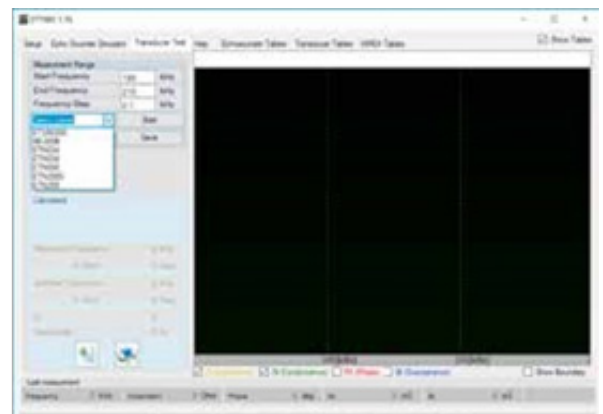
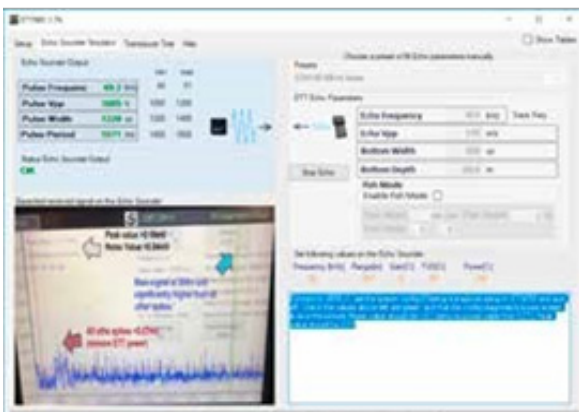

Appendix 1: Installation drawings

The display is designed for flushmount installation

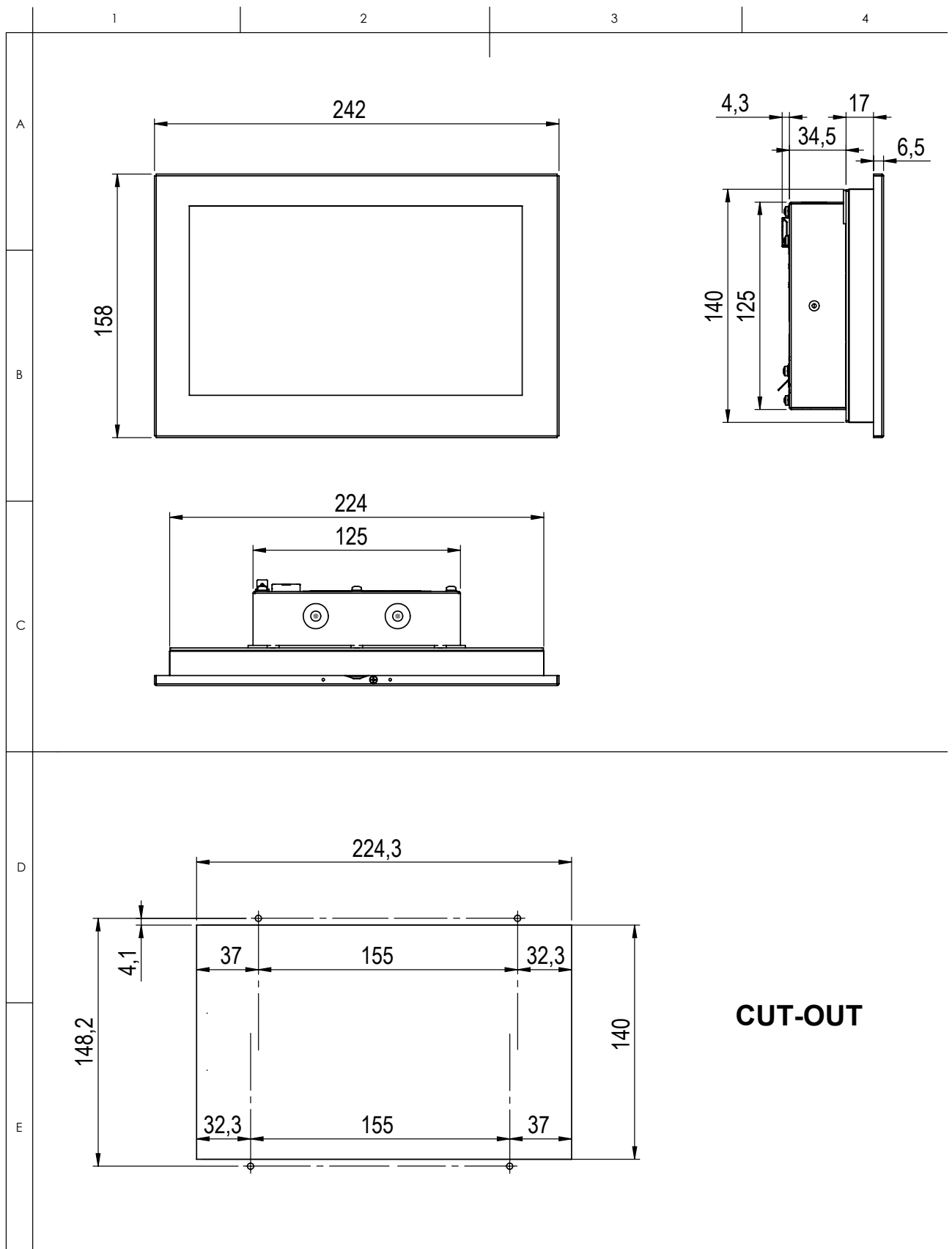

Optional wallmount/desktop bracket.Part number: MG-0002. Mounting bracket for 9inch display

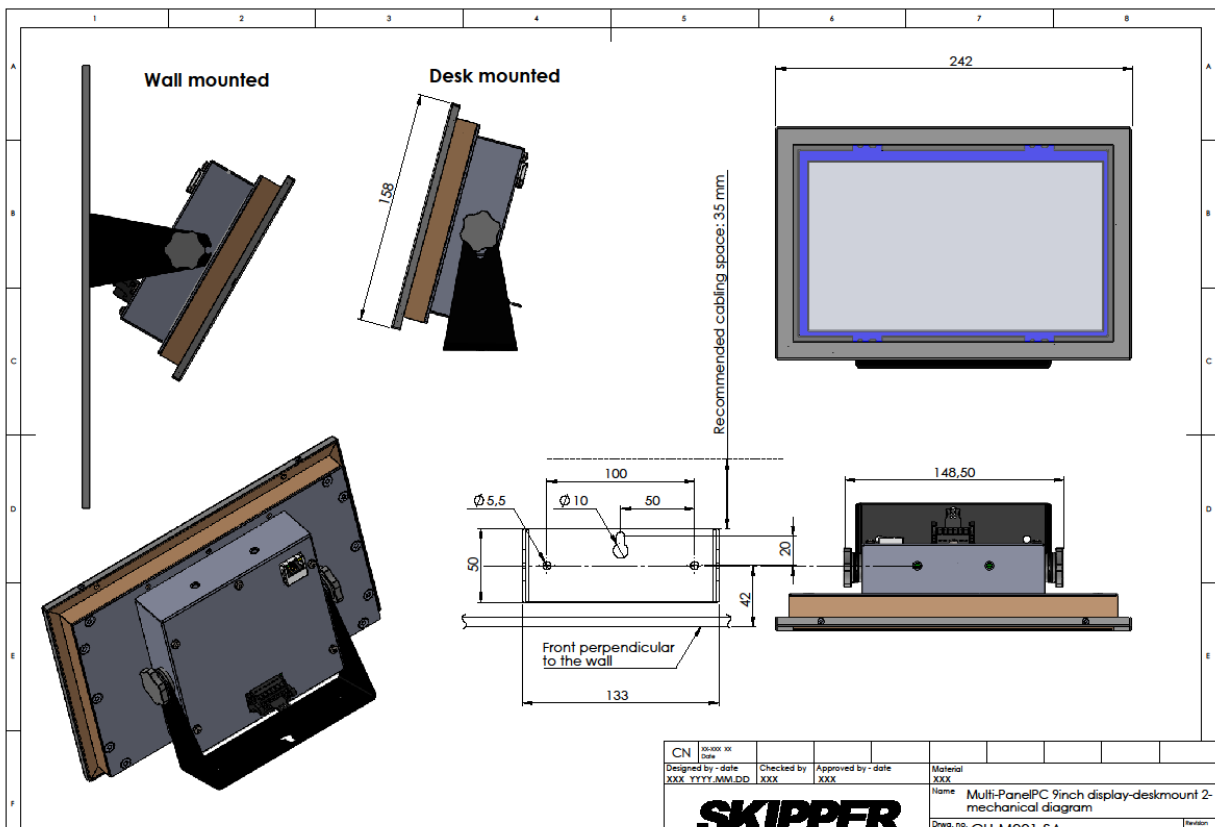
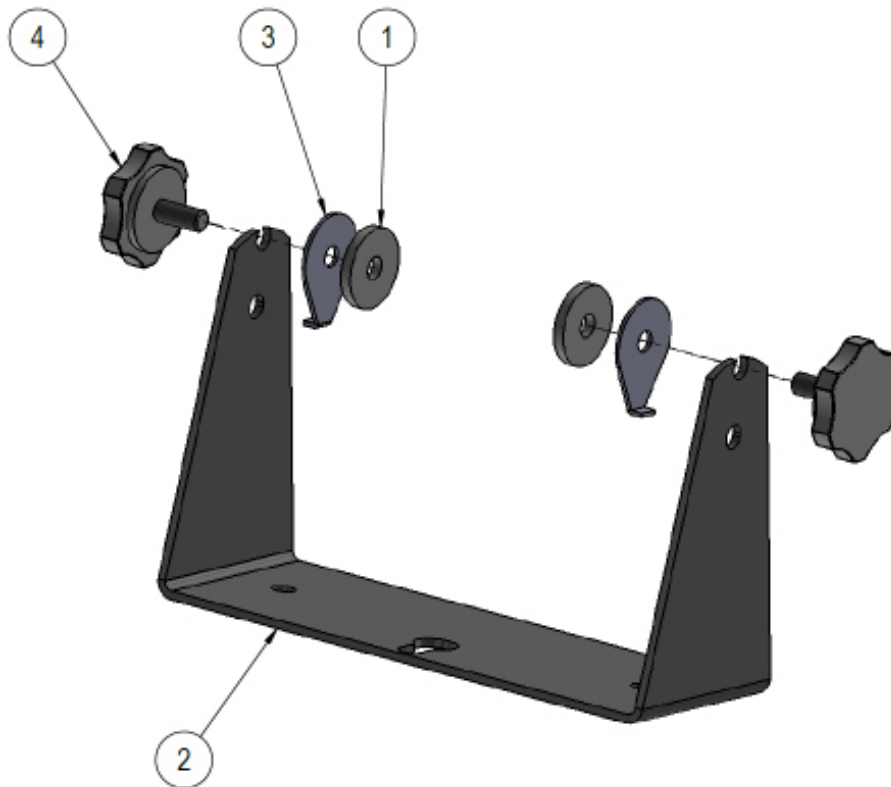

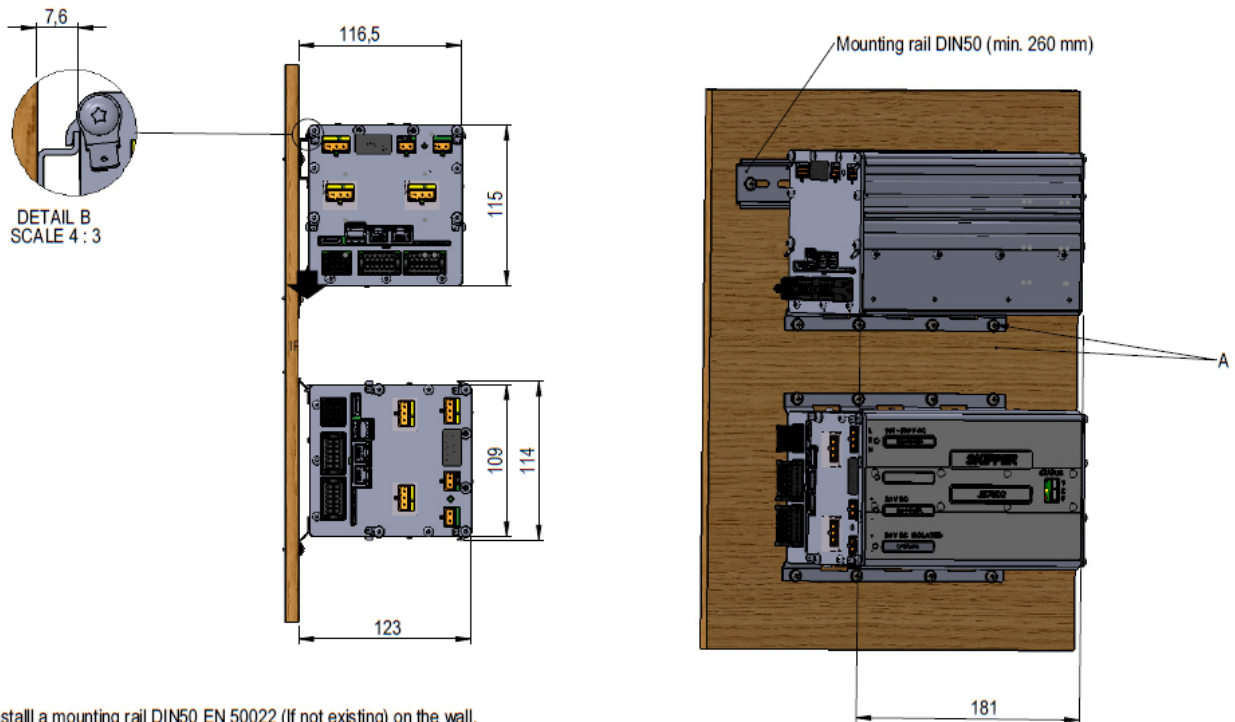

1. Install a mounting rail DIN50 EN 50022 (If not existing) on the wall.
2. Mount the JB70E2-SA on the rail (Be sure that the unit is properly mounted, see detail B)
3. Mark the 4 centerpoints for the drill in the wall (A). NB! The drilling holes diam. depends on thickness and material of the wall.
4. Use self tapping screws ST3,5 DIN7981-C pozidrive (A) (The screw length depends on the wall thickness).

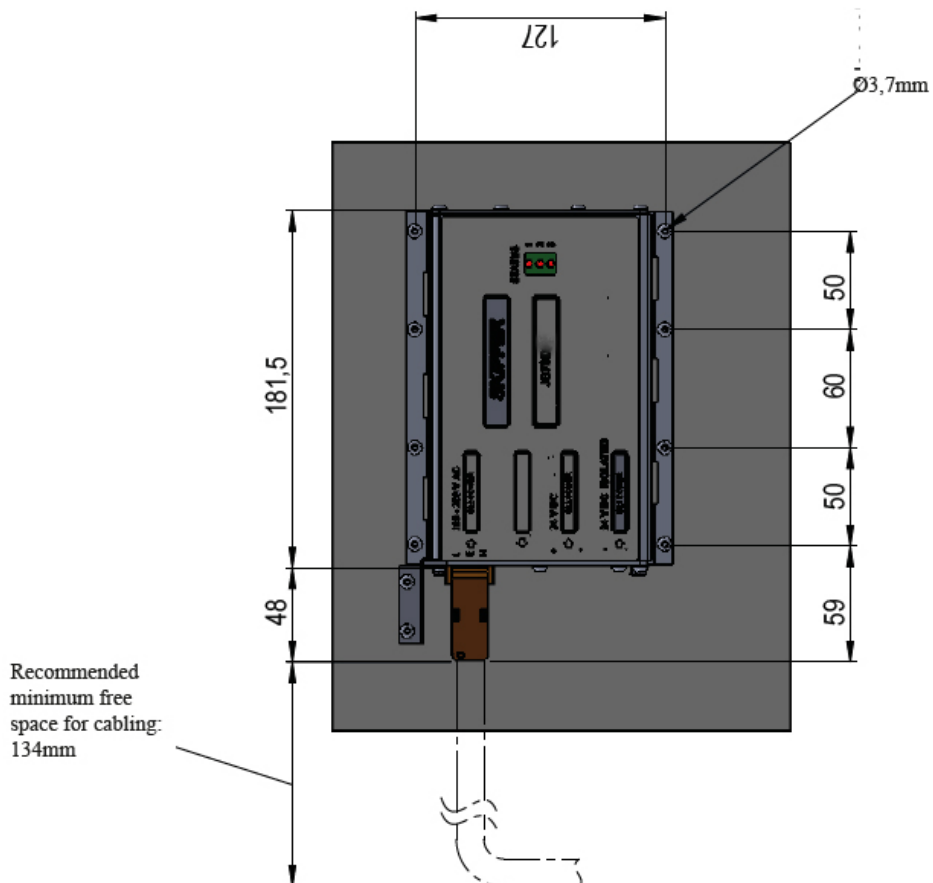

ENS518-SA Transducer selector

The ESN200 has two transducer terminals selectable from software. A transducer selector switch can be installed if more than two transducers are required.

The transducer selector switch will only be able to select between two transducers of same type and frequency

There are no selector feedback to ESN200 for indication of for/aft transducer is selected.

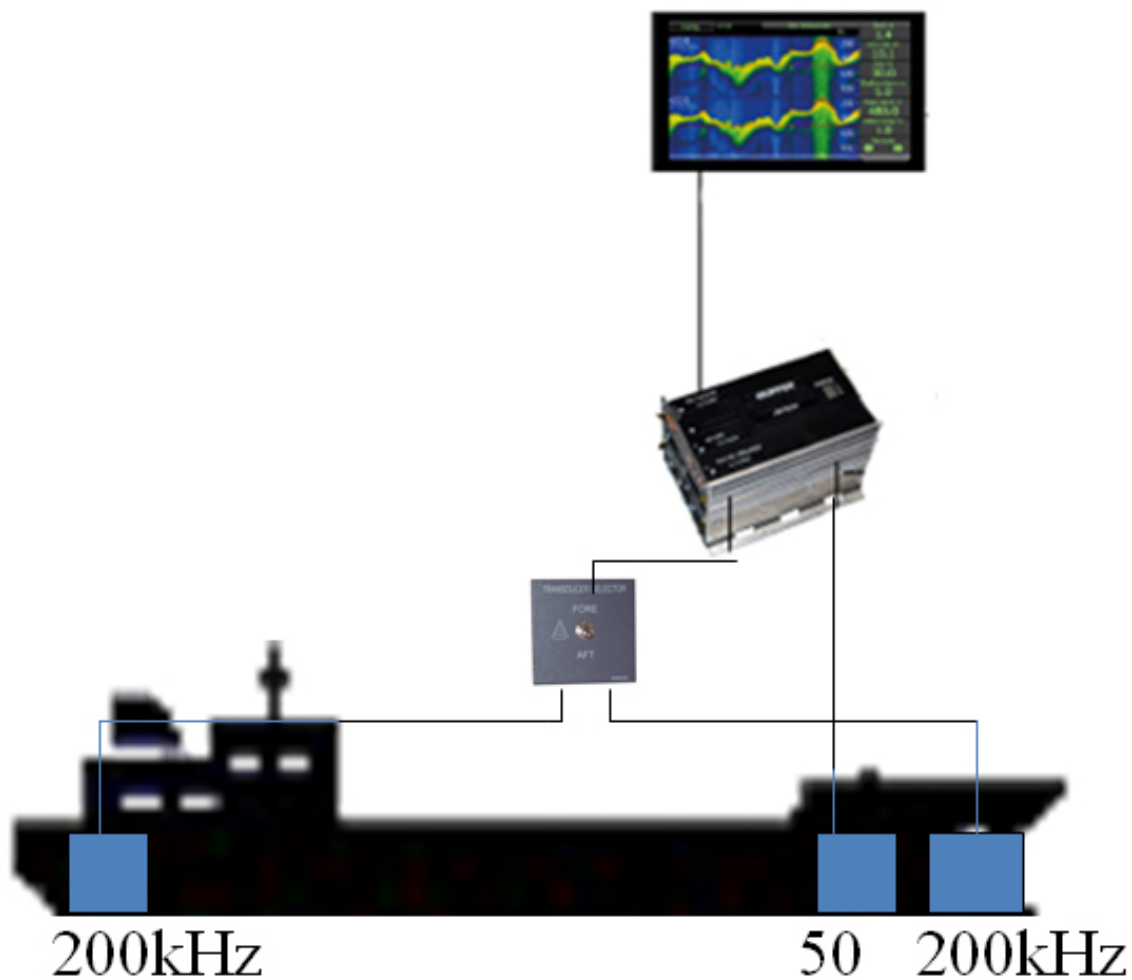

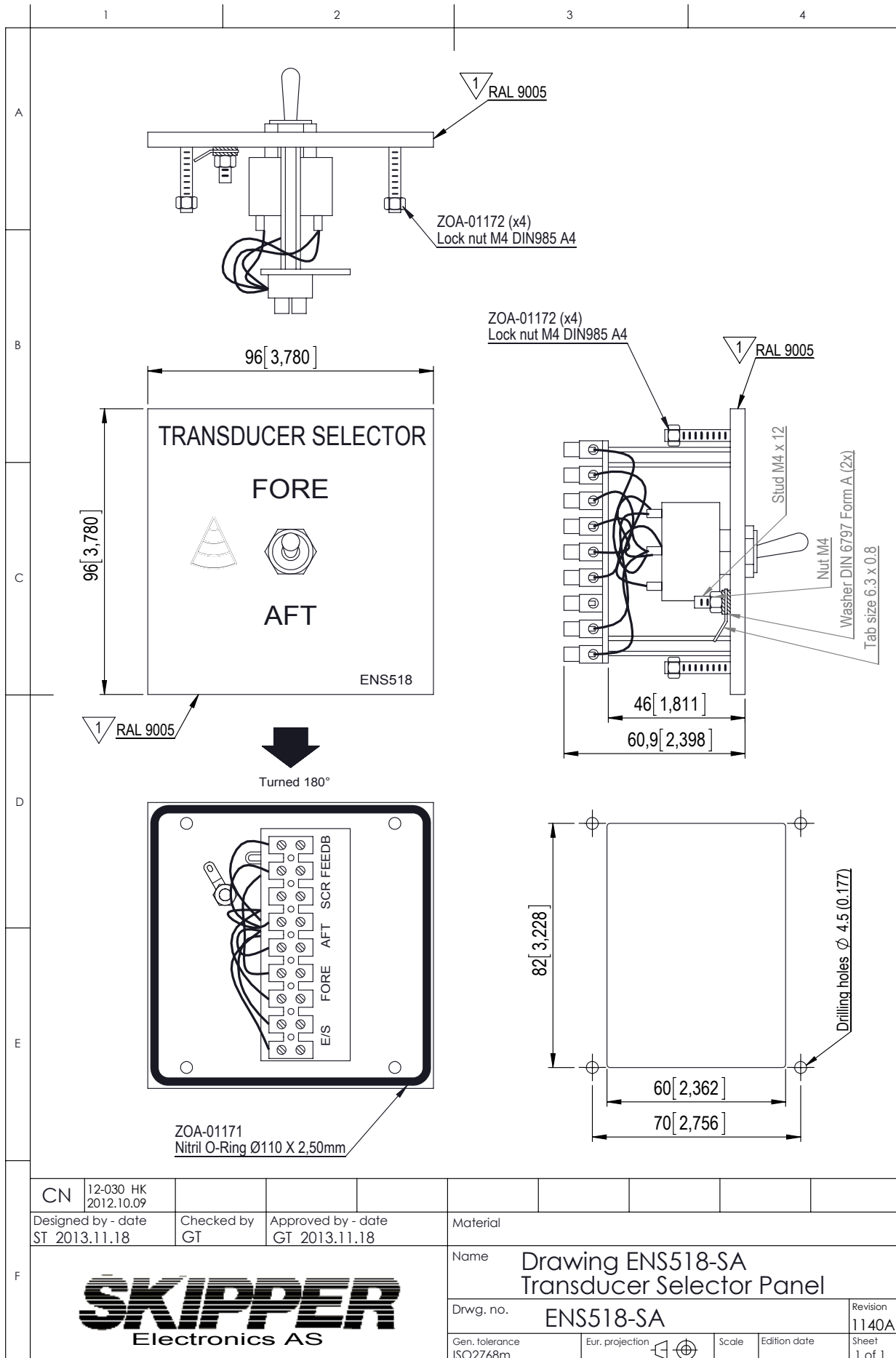

F	CN	12-030 HK 2012.10.09									
	Designed by - date	ST 2013.11.18	Checked by	GT	Approved by - date	GT 2013.11.18	Material				
								Name		Drawing ENS518-SA Transducer Selector Panel	
								Drwg. no.	ENS518-SA	Revision	1140A
				Gen. tolerance	ISO2768m	Eur. projection		Scale		Edition date	
										Sheet	1 of 1

Appendix 2: Remote control

The ESN200 has a number of NMEA message inputs that can be used to remote control the unit. These use the EPV format, and currently the following are available:

To the JB unit

\$XXEPV,C,SD,0108,0002,0*nn - Standby off

\$XXEPV,C,SD,0108,0002,1*nn - Standby on

\$\$XXEPV,C,SD,0108,2001,0*nn - Mute OFF*

\$XXEPV,C,SD,0108,2001,1*nn - Mute ON*

\$XXEPV,C,SD,0108,2001,2*nn - Sync in (ping now) when mute is on, or Aux input is set to 'synch in'*

*these functions require an activated sync option

To the display

\$XXEPV,C,SD,0109,2003,1*nn - Gain up**

\$XXEPV,C,SD,0109,2003,0*nn - Gain dn**

\$XXEPV,C,SD,0109,2004,1*nn - Range up **

\$XXEPV,C,SD,0109,2004,0*nn - Range dn **

\$XXEPV,C,SD,0109,2005,1*nn - Pic speed up

\$XXEPV,C,SD,0109,2005,0*nn - Pic speed dn

\$XXEPV,C,SD,0109,2006,1*nn - Auto on

\$XXEPV,C,SD,0109,2006,0*nn - Auto off**

\$XXEPV,C,SD,0109,2007,0*nn - Transducer Right

\$XXEPV,C,SD,0109,2007,1*nn - Transducer Left





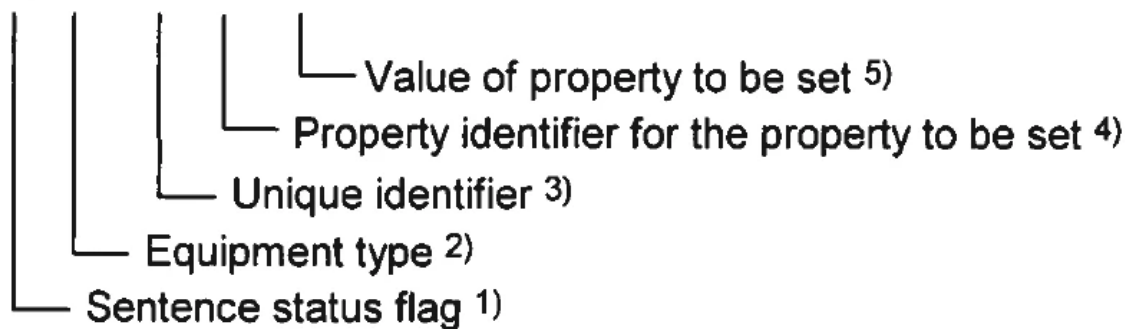





** manual functions are only available when Auto is off

\$--EPV,a,c--c,c--c,x.x,c--c*hh<CR><LF>



- 1) C is command, system replies with R
- 2) Equipment type is SD for echosounder
- 3) Unique identifier is the 4 digit SFI number, normally 0108 or 0109
- 4) The parameter identifier
- 5) The parameter state

Table of abbreviations

Symbol/abbreviation	Explanation
TVG	Time variable gain
FWD	Forward position
AFT	Aft position
<i>PORT</i>	Portside
<i>STBD</i>	Starboardside
Pic Speed	Picture speed. The amount of time presented on the screen
DBT	Depth below transducer
DBS	Depth below surface
DBK	Depth below keel
Draft	Depth from water surface to the lowest point of the vessel
Offset	Distance from Transducer to the lowest point of the vessel
<i>DPTH</i>	Depth
<i>M</i>	Meters
<i>ft</i>	Feet
<i>fm</i>	Fathoms
m/s	Speed in meters / second
kHz	kilohertz (Frequency)
<i>hr</i>	hour
<i>min</i>	minute
(A)	Automatic mode (system self adjusts range and gain)
(P)	Primary Channel
ALF	Alarm method according to IEC62923/62288 / MSC 302 with category (CAT) A - Alarm to be acknowledged on the display only B – Alarm may be acknowledged remotely To work with ACN – Alarm Acknowledge, request, transfer, silence
ALR	Older alarm standard to work with ACK Acknowledge
 	Active Alarm/Warning unacknowledged alarm
 	Active Alarm/Warning acknowledged Alarm
 	Alarm/Warning rectified but unacknowledged
 	Alarm/Warning responsibility transferred
 	Alarm/Warning silenced for 30 seconds

S	Simulate mode
M	Mute Mode (see options section)

V	Volts
DC	Direct Current (for voltage)
CAM	Central alarm management
INS	Integrated navigation system
LAN	Local area network
SFI	System function identifier, from standard IEC61162-450
UDP	Data sent on the LAN ports
MAC	Unique system identifier for LAN system
IP	Internet protocol address, unique in the network

SKIPPER

SKIPPER Electronics AS
Enebakkveien 150
P. O. Box 151, Manglerud
0612 Oslo, Norway

Telephone: +47 23 30 22 70
www.skipper.no
E-mail: support@skipper.no
Co. reg. no: NO-965378847-MVA